



Standard Power Supplies

From The World's No.1 Power Supply Company



www.DeltaPSU.com



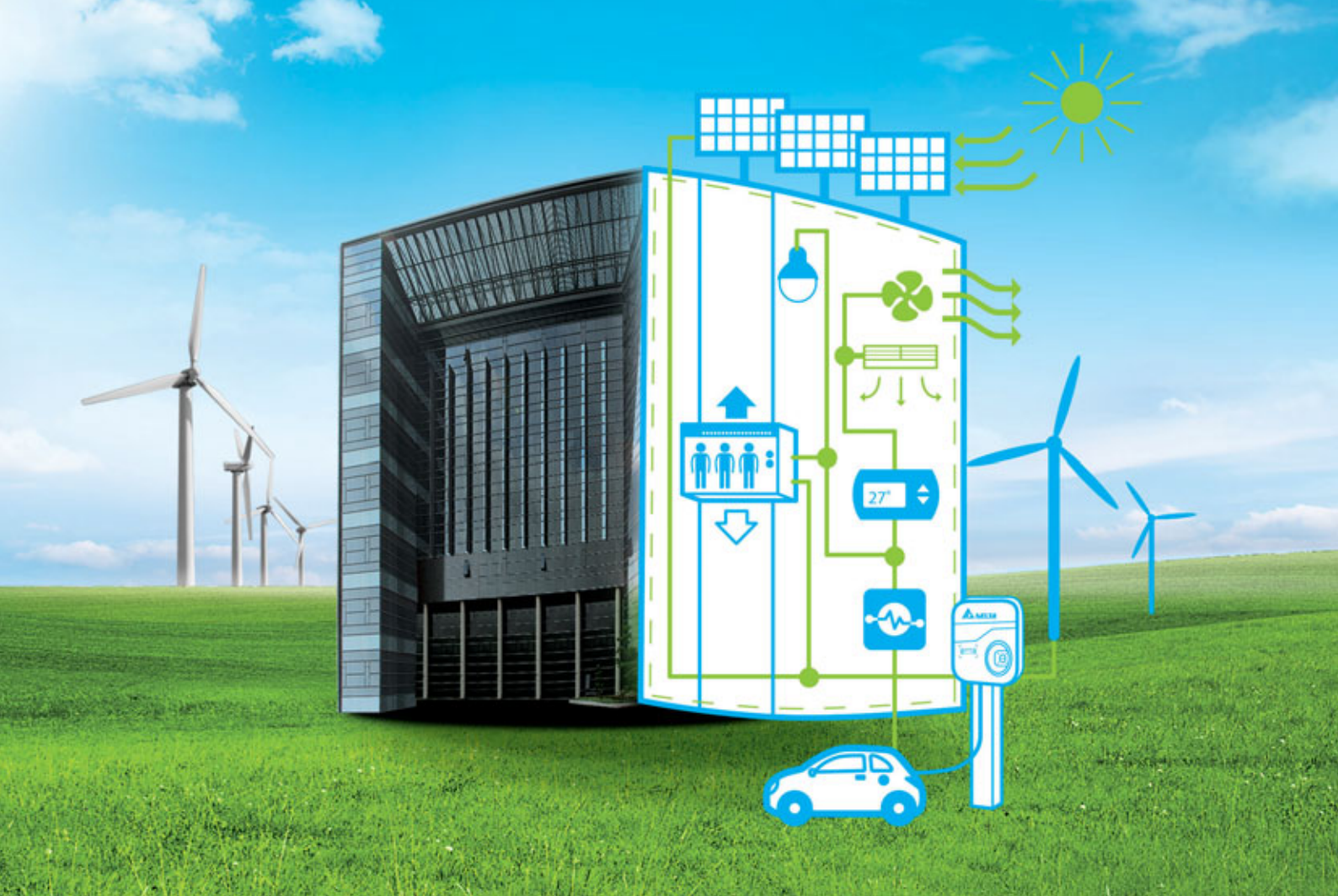

| ABOUT DELTA

Delta was founded in 1971 and has been the global leader in switching power supply solutions since 2002 and DC brushless fans since 2006. Delta offers some of the most energy efficient power products in the industry, including switching power supplies with efficient over 90%, telecom power with up to 98%, and PV inverters with up to 98.8% efficient. We have also developed the world's first server power supply certified as 80 Plus Titanium with over 96% efficient. We regularly invest 6% to 7% of our annual sales revenues in R&D and have worldwide R&D facilities in Taiwan, China, Europe, India, Japan, Singapore, Thailand, and the U.S.

| BUSINESS CATEGORIES



Power Electronics

- Components
- Embedded Power
- Fan & Thermal Management
- Automotive Electronics
- Merchant & Mobile Power

Innergie



Automation

- Industrial Automation
- Building Automation



Infrastructure

- ICT Infrastructure
- Energy Infrastructure & Industrial Solutions

vivitek
POWERING THE WORLD

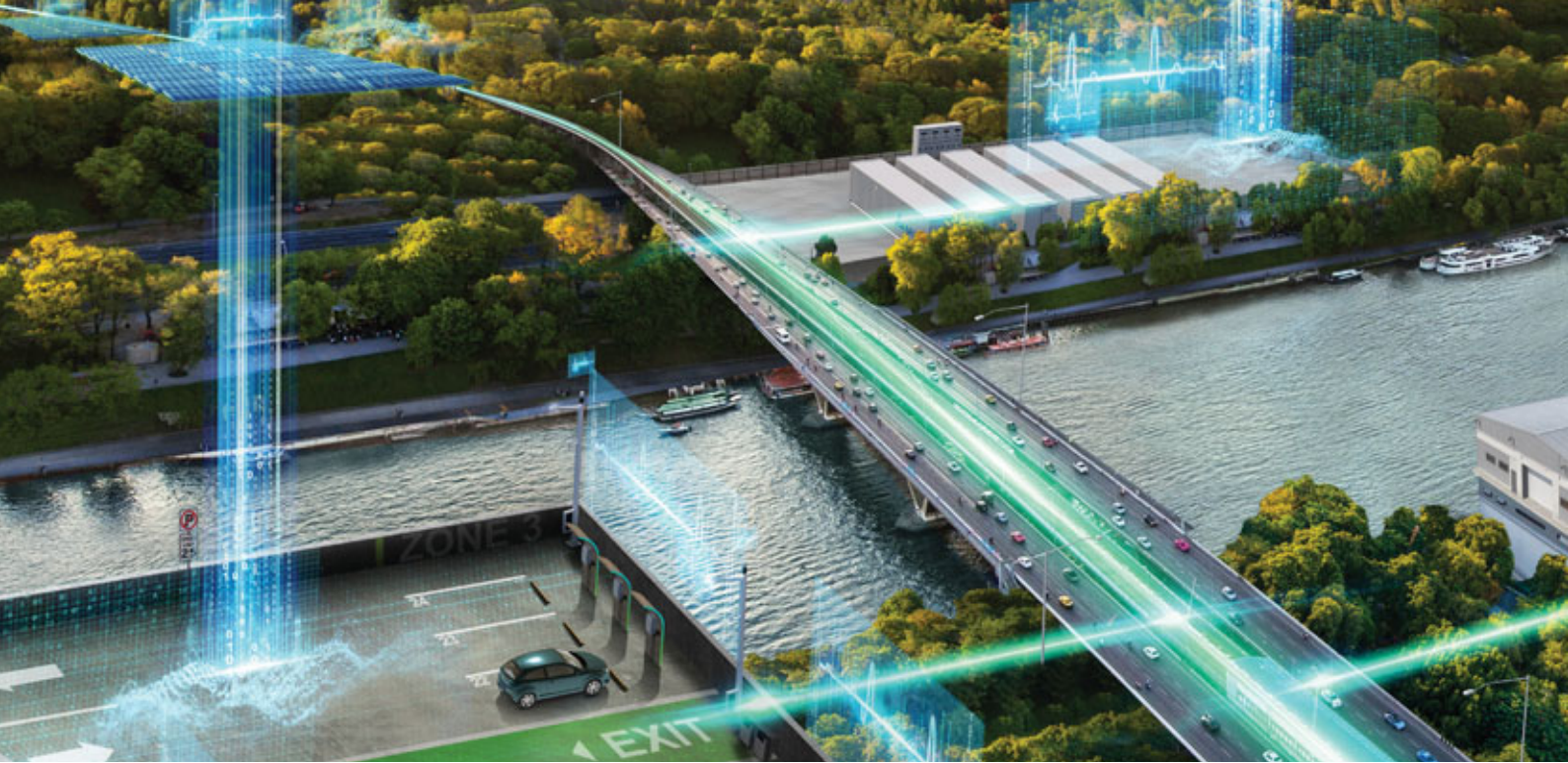

INDEX

Applications	01-02
Latest Products	03
Product Selection Guide	04-16
Industrial Power Supplies	17-85
DIN Rail Power Supply	19-38
CliQ (15W - 480W)	21-22
CliQ II (60W - 960W)	23-27
CliQ III (120W - 480W)	28
CliQ M (81.6W - 960W)	29-31
CliQ VA (120W - 480W)	32
Lyte (75W - 480W)	33-34
Chrome (7.5W - 91.2W)	35-36
Sync (15W - 91.2W)	37-38
Panel Mount Power Supply	39-65
PMT (35W - 350.4W)	41-45
PMT2 (36W - 350.5W)	46-52
PMC (15W - 600W)	53-58
PMH (50W - 200W)	59-61
PMF (200W - 320W)	62
PMR (252W - 300W)	63-64
PMU (151W)	65
Open Frame Power Supply	65-78
PJT (40W - 150W)	66-71
PJ (15W - 150W)	72-74
PJB (100W - 300W)	75
PJH (300W)	76
PJU (60W)	77
PJL (200W - 400W)	78











DIN Rail Modules	79-83
CliQ II Redundancy Modules (20A, 40A)	80
CliQ II Buffer Modules (20A, 40A)	81
CliQ II DC-UPS Module (20A)	82
Chrome DC-UPS Module (10A)	83
Adapter	84-85
ADT (60W)	85
Medical Power Supplies	87-117
Enclosed Power Supply	89-104
MDS (200W - 400W)	90-91
MEB (500W - 1,200W)	92-93
Open Frame Power Supply	94-104
MDS (40W - 400W)	95-102
MEP (25W)	103
MEU (260W - 600W)	104
ATX Power Supply	105-106
MDS (350W)	106
Configurable Power Supply	107-108
MEG (1,200W - 2,100W)	108
Adapter	109-117
MDS (5W - 150W)	110-115
MEA (60W - 250W)	116
MEF (5W)	117
Accessories	118-119
FAQs	120
Standards & Approvals	121-129
Augmented Reality (AR)	131
More Information	132
Notes	86, 130, 133

APPLICATIONS

Delta offers an extensive range of standard power supplies in DIN Rail, Panel Mount and Open Frame form factors. For sophisticated and critical applications, Delta offers specific features such as Advanced Power Boost, efficiency levels up to 94%, PMBus communication and more. The fast expanding portfolio offers various solutions in the Industrial, Medical and LED lighting segments.

The application examples below highlight some of the key power supply series suitable to meet the system requirements.

Applicable Series

	CliQ III, Lyte, Chrome, Sync, PMT, PMT2, PMC, PMH, PMU, PJT, PJ, PJU
	CliQ, CliQ II, CliQ III, CliQ M, CliQ VA, Lyte, Chrome, Sync, PMT, PMT2, PMC, PMF, PMU
	CliQ, CliQ II, CliQ III, CliQ M, CliQ VA, Lyte, Chrome, Sync, PMT, PMT2, PMC, PMF, PMU, PJT, PJ, PJB, MEB, MEP, MEU
	CliQ, CliQ II, CliQ III, CliQ M, CliQ VA, Lyte, Chrome, Sync, PMT, PMT2, PMC, PMF, PMU, PJT, PJ, PJB, MEB, MEP, MEU, MEG
	Chrome, Sync, PMT, PMT2, PMC, PJT, PJ, PJB, MEB, MEP, MEU, MEG
	PMT, PMC, PMF, PMR, PJL, MEB
	CliQ, CliQ II, CliQ III, CliQ M, CliQ VA, Lyte, PMC
	MDS, MEB, MEP, MEU, MEG, MEA, MEF
	PMT, PMT2, PMC, PMH, PMF, PJT, PJ, PJB, PJH, PJU



Building Automation

- Escalator & Elevator
- CCTV Surveillance
- HVAC Control



Process Automation

- Petrochemicals Plant
- Waste Water Treatment
- Oil Refinery



Factory Automation

- Packaging Machine
- Wave Soldering Machine
- Conveyor Systems



Machine Automation

- Robotic Arm
- Injection Molding Machine



Renewable Energy

- Wind Turbine
- Solar Tracker System



Test & Measurement

- Spectrum Analyzers
- AC Power Source
- Oscillators



Medical Equipment

- Medical Beds
- Portable Oxygen Concentrator
- Dialysis Equipment



LED Lighting

- Stage Lighting
- Signage



Food & Beverage

- Coffee Machine
- Vending Machine
- Kiosk

LATEST PRODUCTS

| Industrial Power Supplies

CliQ M

Slim Design with SIL 3 Approval



CliQ^M

24V
480W SIL 3

PAGE 30

CliQ M

Slim Design with Advanced Power Boost (APB)



CliQ^M

24V
480W - 960W 3-Phase

PAGE 31

Lyte

Built-in Constant Current



LYTE

12V, 24V, 48V
75W

PAGES 33-34

PMT2

Panel Mount with Low Profile Design (30mm)



PMT2

12V - 48V, Dual
35W - 350W

PAGES 46-52

PJB

Open Frame with Power Boost Function

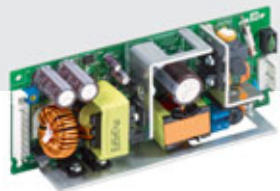

PJB

24V
150W - 300W

PAGE 75

| Medical Power Supplies

MEB

High Power Density & Built-in Remote ON/OFF



MEB

24V
500W

PAGE 92

MEA

Desktop Adapter with Efficiency Level VI



MEA

12V, 24V
60W - 65W

PAGE 116

PRODUCT SELECTION GUIDE

Industrial Power Supplies

New products are frequently introduced. Please visit www.DeltaPSU.com for latest product updates.

Product Type	Series	Model Name	Phase			PFC	Output Voltage	Output Current	Output Power	Input Voltage Range*	Page		
			1	2	3								
DIN Rail Power Supply	CliQ • Terminal block • Power Boost up to 3s (except DRP-24V48W1AZ)	DRP012V015W1A□	•				12V	1.25A	15W	85-264Vac (DC input range 120-375Vdc)	21		
		DRP012V030W1A□	•					2.5A	30W				
		DRP012V060W1AA	•					5.0A	60W				
		DRP012V100W1AA	•					8.33A	100W				
		DRP-24V48W1AZ	•				24V	2.0A	48W			85-264Vac (DC input range 120-375Vdc)	22
		DRP024V060W1AZ	•					2.5A	60W				
		DRP024V060W1AA	•					2.5A	60W				
		DRP024V120W1AA	•			•		5.0A	120W				
		DRP024V240W1AA	•			•		10.0A	240W				
	DRP024V480W1AA	•			•	20.0A		480W					
	DRP024V060W1B□	•				24V		2.5A	60W	85-264Vac (DC input range 120-375Vdc)	23		
	DRP024V120W1B□	•						5.0A	120W				
	DRP024V240W1B□	•			•		10.0A	240W					
	DRP024V480W1B□	•			•		20.0A	480W					
	DRP024V060W1N□	•					2.5A	60W	85-264Vac (DC input range 120-375Vdc)			24	
	DRP-24V100W1NN	•			•		3.8A	91.2W					
	DRP-24V120W2BN	•	•				5.0A	120W	2 × 180-550Vac or 180-305Vac (Single Phase) (DC input range 254-780Vdc)	25			
	DRP-24V240W2BN	•	•		•		10.0A	240W					
	DRP024V060W3B□	•	•	•			2.5A	60W	3 × 320-600Vac or 2 × 360-600Vac (DC input range 450-800Vdc)	26			
	DRP024V120W3B□	•	•	•			5.0A	120W					
	DRP024V240W3B□	•	•	•			10.0A	240W					
	DRP024V480W3B□	•	•	•	•		20.0A	480W					
	DRP024V960W3BN	•	•	•	•		40.0A	960W	For 960W: 3 × 320-600Vac or 2 × 380-600Vac (DC input range 450-800Vdc)	85-264Vac (DC input range 120-375Vdc)	27		
	DRP048V060W1B□	•					48V	1.25A	60W				
	DRP048V120W1B□	•			•			2.5A	120W				
	DRP048V240W1B□	•			•			5.0A	240W				
	DRP048V480W1B□	•			•	10.0A		480W					
	DRP-24V120W1CAN	•			•	24V		5.0A	120W	88-264Vac	28		
	DRP-24V120W1CBN	•			•		5.0A	120W	88-264Vac (DC input range 88-375Vdc)				
	DRP-24V240W1CAN	•			•		10.0A	240W	88-264Vac				
	DRP-24V240W1CBN	•			•		10.0A	240W	88-264Vac (DC input range 88-375Vdc)				
	DRP-24V480W1CAN	•			•		20.0A	480W	88-264Vac				
DRP-24V480W1CBN	•			•	20.0A		480W	88-264Vac (DC input range 88-375Vdc)					

* DC input is certified for selected models

DIN Rail Power Supply Model Numbering

DR	P	XXXV	XXXW	1	A	□	
DIN Rail	Product Type P - Power Supply	Output Voltage	Output Power	Phase Input 1 - Single Phase	A - CliQ Series	A - Metal case, with Class I, Div 2 and ATEX approvals Y - Plastic case, with Class I, Div 2 and ATEX approvals Z - Plastic case, without Class I, Div 2 and ATEX approvals	
DR	P	XXXV	XXXW	□	□	□	
DIN Rail	Product Type P - Power Supply	Output Voltage	Output Power	Phase Input 1 - Single Phase 2 - Two Phase 3 - Three Phase	B - CliQ II Series N - NEC Class 2	A - Metal case, with Class I, Div 2 and ATEX approvals N - Metal case, without Class I, Div 2 and ATEX approvals Y - Plastic case, with Class I, Div 2 and ATEX approvals Z - Plastic case, without Class I, Div 2 and ATEX approvals	
DR	P-	XXV	XXXW	1	C	□	N
DIN Rail	Product Type P - Power Supply	Output Voltage	Output Power	Phase Input 1 - Single Phase	C - CliQ III Series	Input Voltage A - AC Input B - AC & DC Input	N - Metal case, without Class I, Div 2 and ATEX approvals

PRODUCT SELECTION GUIDE

Industrial Power Supplies

New products are frequently introduced. Please visit www.DeltaPSU.com for latest product updates.

Product Type	Series	Model Name	Phase			PFC	Output Voltage	Output Current	Output Power	Input Voltage Range*	Page	
			1	2	3							
DIN Rail Power Supply	CliQ M <ul style="list-style-type: none"> Slim design with high power density Advanced Power Boost Maritime approvals 	DRM-24V80W1PN	•			•	24V	3.4A	81.6W	85-276Vac (DC input range 88-375Vdc)	29	
		DRM-24V120W1PN	•			•		5.0A	120W	85-264Vac (DC input range 88-375Vdc)		
		DRM-24V240W1PN	•			•		10.0A	240W	85-276Vac (DC input range 88-375Vdc)		
		DRM-24V480W1PN	•			•		20.0A	480W			
		DRM-24V960W1PN	•			•		40.0A	960W	85-264Vac		
		DRM-24V480W1SN	•			•		20.0A	480W	85-276Vac (DC input range 88-375Vdc)		
		DRM-24V480W3PN		•	•	•		20.0A	480W	3 × 320-600Vac or 2 × 380-600Vac		
		DRM-24V960W3PN		•	•	•		40.0A	960W			
	CliQ VA <ul style="list-style-type: none"> Smart monitoring function Advanced Power Boost 	DRV-24V120W1PN	•			•	24V	5.0A	120W	85-264Vac (DC input range 88-375Vdc)	32	
		DRV-24V240W1PN	•			•		10.0A	240W	85-276Vac (DC input range 88-375Vdc)		
		DRV-24V480W1PN	•			•		20.0A	480W			
	Lyte <ul style="list-style-type: none"> Competitively priced Built-in constant current circuit 	DRL-12V75W1AZ	•				12V	6.25A	75W	85-264Vac	33	
		DRL-24V75W1AZ	•				24V	3.125A	75W			
		DRL-24V120W1A□	•					5.0A	120W	85-264Vac (DC input range 120-375Vdc)		
		DRL-24V240W1A□	•			•		10.0A	240W			
		DRL-24V480W1A□	•			•		20.0A	480W			
		DRL-48V75W1AZ	•					48V	1.57A	75.36W		85-264Vac
	Chrome <ul style="list-style-type: none"> Compact Class II double isolation NEC Class 2 	DRL-48V120W1A□	•					2.5A	120W	85-264Vac (DC input range 120-375Vdc)	34	
		DRC-5V10W1A□	•				5V	1.5A	7.5W	90-264Vac		
		DRC-12V10W1A□	•				12V	0.83A	10W			
		DRC-12V30W1A□	•					2.1A	25.2W			
		DRC-12V60W1A□	•					4.5A	54W			
		DRC-12V60W1C□	•					4.5A	54W	90-264Vac (DC input range 125-375Vdc)		
		DRC-12V100W1AZ	•					6.0A	72W	90-264Vac		
		DRC-24V10W1A□	•					24V	0.42A	10W		90-264Vac
		DRC-24V10W1HZ	•						0.42A	10W		
		DRC-24V30W1A□	•						1.25A	30W		
	DRC-24V60W1A□	•						2.5A	60W			
DRC-24V100W1A□	•						3.8A	91.2W	90-264Vac (DC input range 125-375Vdc)			

* DC input is certified for selected models

DIN Rail Power Supply Model Numbering

DR	M –	XXV	XXXW	□	□	N
DIN Rail	Product Series M - CliQ M Series	Output Voltage	Output Power	Phase Input 1 - Single Phase 3 - Three Phase	P - Advanced Power Boost (APB) S - SIL 3	N - Metal case, without Class I, Div 2 and ATEX approvals

DR	V –	XXV	XXXW	1	P	N
DIN Rail	Product Series V - CliQ VA Series	Output Voltage	Output Power	Phase Input 1 - Single Phase	Advanced Power Boost (APB)	N - Metal case, without Class I, Div 2 and ATEX approvals

DR	L –	XXV	XXXW	1	A	□
DIN Rail	Product Series L - Lyte Series	Output Voltage	Output Power	Phase Input 1 - Single Phase	Standard Bracket	A - Metal case without DC OK Relay Contact S - Metal case with DC OK Relay Contact Z - Plastic case without DC OK Relay Contact

DR	C –	XXV	XXXW	1	□	□
DIN Rail	Product Type C - Isolation Class II Power Supply	Output Voltage	Output Power	Phase Input 1 - Single Phase	A - No PFC C - AC & DC Input, No PFC H - Household Approval	Z - Black plastic case G - Grey plastic case C - Black plastic case, with conformal coating ¹⁾

1) Options for DRC-24V60W1A□ and DRC-24V100W1A□ only

DR	S –	XXV	XXXW	1	□	□
DIN Rail	Product Series S - Sync Series	Output Voltage	Output Power	Phase Input 1 - Single Phase	A - Non NEC Class 2 N - NEC Class 2	Z - Without DC OK Relay Contact R - With DC OK Relay Contact

Industrial Power Supplies

New products are frequently introduced. Please visit www.DeltaPSU.com for latest product updates.

Product Type	Series	Model Name	Phase	PFC	Output Voltage	Output Current	Output Power	Input Voltage Range*	Page		
			1								
DIN Rail Power Supply	Sync • Compact • NEC Class 2 • Competitively priced	DRS-5V30W1NZ	•		5V	3.0A	15W	85-264Vac (DC input range 120-375Vdc)	37		
		DRS-5V50W1A□	•			6.0A	30W				
		DRS-5V50W1N□	•			5.0A	25W				
				DRS-12V50W1N□	•		12V	4.0A	48W	85-264Vac	38
				DRS-24V30W1AZ	•		24V	1.25A	30W	85-264Vac (DC input range 120-375Vdc)	
				DRS-24V30W1NZ	•			1.25A	30W		
				DRS-24V50W1N□	•			2.1A	50W		
				DRS-24V100W1A□	•	•		4.0A	96W		
		DRS-24V100W1N□	•	•		3.8A	91.2W				

* DC input is certified for selected models

Product Type	Series	Model Name	Phase	PFC	Output Voltage	Output Current	Output Power	Input Voltage Range	Page
			1						
Panel Mount Power Supply	PMT • AC input voltage selectable switch • High MTBF	PMT-4V350W1A□	•		4.2V	60.0A	252W	90-132Vac, 180-264Vac (Selectable by Switch)	41
		PM□-5V35W1A□	•		5V	7.0A	35W	85-264Vac	
		PM□-5V50W1A□	•			10.0A	50W	90-132Vac, 180-264Vac (Selectable by Switch)	42
		PMT-5V350W1A□	•		60.0A	300W			
		PM□-12V35W1A□	•		12V	2.92A	35W	90-264Vac	
		PM□-12V50W1A□	•			4.2A	50W		
		PM□-12V100W1A□	•		8.5A	102W	90-132Vac, 180-264Vac (Selectable by Switch)	43	
		PM□-12V150W1A□	•		12.5A	150W			
		PMT-12V350W1A□	•		29.0A	348W	85-264Vac	44	
		PM□-15V50W1A□	•		15V	3.4A			51W
		PM□-24V35W1A□	•		24V	1.46A	35W	90-264Vac	
		PM□-24V50W1A□	•			2.09A	50W		
		PM□-24V100W1A□	•		4.5A	108W	90-132Vac, 180-264Vac (Selectable by Switch)	45	
		PM□-24V150W1A□	•		6.5A	156W			
		PM□-24V200W1A□	•		8.8A	211.2W	90-132Vac, 180-264Vac (Selectable by Switch)	44	
		PMT-24V350W1AG	•		14.6A	350.4W			
		PMT-24V350W1AM	•		14.6A	350.4W	90-132Vac, 180-264Vac (Selectable by Switch)	45	
		PMT-24V350W1AK	•		14.6A	350.4W			
		PMT-24V350W1AR	•		14.6A	350.4W			
		PMT-36V350W1A□	•		36V	9.7A	349.2W	90-132Vac, 180-264Vac (Selectable by Switch)	45
		PM□-48V150W1A□	•		48V	3.3A	158.2W		
		PMT-48V350W1A□	•			7.3A	350W	88-132Vac, 176-264Vac (Selectable by Switch)	45
		PM□-D1V100W1A□	•		12V/5V	7.0A/3.0A	99W		
		PM□-D2V100W1A□	•		24V/5V	3.5A/3.0A	99W		

Panel Mount Power Supply Model Numbering

PM	□ -	XXV	XXXW	1	A	□	□	CC Code ⁶⁾
Panel Mount	Product Type T - Enclosed L - L Frame ¹⁾ B - Open Frame ²⁾	Output Voltage	Output Power	Phase Input 1 - Single Phase	No PFC	Connector Type <u>With UL, TUV, CE, CCC</u> A - Terminal Block G - Front Face ^{3) 5)} H - Harness ³⁾ <u>With UL, TUV, CE</u> R - Terminal Block K - Front Face ⁴⁾ <u>With UL</u> M - Terminal Block ⁵⁾ N - Front Face	Blank - Without connector cover A - With connector cover B - With conformal coating C - With conformal coating and connector cover	
PM	□ -	XXV	XXXW	1	A	□	□	CC Code ⁶⁾
Panel Mount	Product Type T - Enclosed L - L Frame ¹⁾	Output Voltage Dual Output D1 - 12V / 5V D2 - 24V / 5V	Output Power	Phase Input 1 - Single Phase	No PFC	Connector Type A - Terminal Block G - Front Face ⁷⁾ H - Harness ⁷⁾	Blank - Without connector cover B - With conformal coating	

1) Options for 35W-200W

2) Options for 35W and 50W (except for 5V/35W, 5V/50W and 15V/50W models)

3) Options (Harness connector is not available for 5V/50W model)

4) Options for PMT-24V350W1AK, PMT-36V350W1A□ and PMT-48V350W1A□

5) PMT-24V350W1AG and PMT-24V350W1AM is certified to UL only

6) Options for Terminal Block with Enclosed type only

A - For 4V/350W, 5V/350W, 24V/35W-100W models

B - For 4V/350W, 5V/350W, 12V/35W-150W, 24V/35W-200W models

C - For PMT-4V350W1AM and PMT-5V350W1AM

7) Options for dual output

PRODUCT SELECTION GUIDE

Industrial Power Supplies

New products are frequently introduced. Please visit www.DeltaPSU.com for latest product updates.

Product Type	Series	Model Name	Phase	PFC	Output Voltage	Output Current	Output Power	Input Voltage Range	Page
			1						
Panel Mount Power Supply	PMT2 • Universal AC input voltage • Low profile 30mm height	PMT-12V35W2BA□	•		12V	3.0A	36W	90-264Vac	46
		PMT-12V50W2BA□	•			4.2A	50.4W		
		PMT-12V75W2BA□	•			6.0A	72W		
		PMT-12V100W2BA□	•			8.5A	102W		
		PMT-12V150W2BA□	•		15V	12.5A	150W	90-132Vac, 180-264Vac (Selectable by Switch)	47
		PMT-12V350W2BM	•			29.0A	348W		
		PMT-12V350W2BR□	•			29.0A	348W		
		PMT-15V35W2BA	•			2.4A	36W		
		PMT-15V50W2BA	•		24V	3.4A	51W	90-264Vac	48
		PMT-15V75W2BA	•			5.0A	75W		
		PMT-15V100W2BA	•			7.0A	105W		
		PMT-15V150W2BA	•			10.0A	150W		
		PMT-24V35W2BA□	•		30V	1.5A	36W	90-132Vac, 180-264Vac (Selectable by Switch)	49
		PMT-24V50W2BA□	•			2.2A	52.8W		
		PMT-24V75W2BA□	•			3.2A	76.8W		
		PMT-24V100W2BA□	•			4.5A	108W		
		PMT-24V150W2BA□	•		36V	6.25A	150W	90-264Vac	50
		PMT-24V350W2BM	•			14.6A	350.5W		
		PMT-24V350W2BR□	•			14.6A	350.5W		
		PMT-30V35W2BA	•			1.2A	36W		
		PMT-30V50W2BA	•		48V	1.9A	57W	90-132Vac, 180-264Vac (Selectable by Switch)	51
		PMT-30V75W2BA	•			2.5A	75W		
		PMT-30V100W2BA	•			3.5A	105W		
		PMT-30V150W2BA	•			5.0A	150W		
		PMT-36V35W2BA	•		12V/5V	1.0A	36W	90-264Vac	52
		PMT-36V50W2BA	•			1.45A	52.2W		
		PMT-36V75W2BA	•			2.1A	75.6W		
		PMT-36V100W2BA	•			2.8A	100.8W		
		PMT-36V150W2BA	•		24V/5V	4.3A	154.8W	90-132Vac, 180-264Vac (Selectable by Switch)	51
		PMT-36V350W2BR	•			9.7A	349.2W		
		PMT-48V35W2BA	•			0.8A	38.4W		
		PMT-48V50W2BA	•			1.1A	52.8W		
PMT-48V75W2BA	•		Blank	1.6A	76.8A	Blank - Without connector cover	52		
PMT-48V100W2BA	•			2.3A	110.4W				
PMT-48V150W2BA	•			3.3A	158.4W				
PMT-48V350W2BR	•			7.3A	350.4W				
PMT-D1V75W2BA□	•			4.2A/5.0A	75.4W	90-264Vac			
PMT-D2V75W2BA□	•			2.1A/5.0A	75.4W				

Panel Mount Power Supply Model Numbering

PM	T –	XXV	XXXW	2	B	A	CC Code
Panel Mount	Product Type T - Enclosed	Output Voltage	Output Power	Single Phase with Low Profile	Family Code B - No PFC	Connector Type Terminal Block A - With TUV, UL, CE, CCC, KC, EAC M - With UL, EAC R - With TUV, UL, CE, EAC	Blank - Without connector cover B - With conformal coating ¹⁾ C - With connector cover and conformal coating ¹⁾
Panel Mount	Product Type T - Enclosed	Output Voltage Dual Output D1 - 12V / 5V D2 - 24V / 5V	Output Power	Single Phase with Low Profile	Family Code B - No PFC	Connector Type A - Terminal Block	Blank - Without connector cover

1) Options for PMT-12V35W, PMT-24V35W, PMT-12V50W, PMT-24V50W, PMT-12V350W2BR and PMT-24V350W2BR

Industrial Power Supplies

New products are frequently introduced. Please visit www.DeltaPSU.com for latest product updates.

Product Type	Series	Model Name	Phase	PFC	Output Voltage	Output Current	Output Power	Input Voltage Range*	Page	
			1							
Panel Mount Power Supply	PMC • Aluminium casing • Universal AC input voltage	PMC-05V015W1AA	•		5V	3.0A	15W	85-264Vac (DC input range 125-375Vdc)	53	
		PMC-05V035W1A□	•			7.0A	35W			
		PMC-05V050W1AA	•			10.0A	50W			
		PMC-12V035W1A□	•		12V	3.0A	35W	85-264Vac (DC input range 125-375Vdc)	54	
		PMC-12V050W1A□	•			4.17A	50W			
		PMC-12V060W1NA	•			5.0A	60W			
		PMC-12V100W1A□	•		12V	8.34A	100W	85-264Vac (DC input range 125-375Vdc)	55	
		PMC-12V150W1B□	•	•		12.5A	150W			
		PMC-12V600W1BA	•	•		50.0A	600W			
		PMC-24V035W1A□	•		24V	1.46A	35W	85-264Vac (DC input range 125-375Vdc)	56	
		PMC-24V050W1A□	•			2.1A	50W			
		PMC-24V075W1A□	•			3.12A	75W			
		PMC-24V100W1A□	•		24V	4.17A	100W	85-264Vac (DC input range 125-375Vdc)	57	
		PMC-24V150W1A□	•			6.25A	150W			
		PMC-24V150W2AA	•			6.25A	150W			
		PMC-24V300W1BA	•	•	24V	12.5A	300W	180-264Vac (DC input range 220-375Vdc)	57	
		PMC-24V600W1BA	•	•		25.0A	600W			
		PMC-DSPV100W1A	•			24V/5V	2.7A/7.0A			100W
	PMC-48V150W1BA	•	•	48V	3.125A	150W	85-264Vac (DC input range 125-375Vdc)	58		
	PMC-48V600W1BA	•	•		12.5A	600W				
	PMH • IEC 60335, IEC 61558 approvals • Withstand line input voltage surge 300Vac up to 7 seconds • Low profile (for selected models)	PMH	PMH-24V50WCA□	•		24V	2.1A	50W	85-264Vac (DC input range 120-375Vdc)	59
			PMH-24V100WCA□	•			4.16A	100W		
			PMH-24V100WCC□	•			4.16A	100W		
			PMH-24V100WCN□	•		3.8A	91.2W	85-264Vac (DC input range 120-375Vdc)	60	
			PMH-24V150WCB□	•	•	6.25A	150W			
			PMH-24V150WCD□	•	•	6.25A	150W			
		PMH-24V200WCB□	•	•	12V	8.33A	200W	85-264Vac (DC input range 120-375Vdc)	61	
		PMH-12V100WCL□	•			8.5A	100W			
		PMH-12V100WCM□	•			8.5A	100W			
		PMH-24V100WCL□	•		24V	4.5A	100W	85-264Vac (DC input range 120-375Vdc)	61	
PMH-24V100WCM□		•		3.8A		91.2W				
PMH-24V150WCL□		•		6.5A		150W				

* DC input is certified for selected models

Panel Mount Power Supply Model Numbering

PM	C –	XXV	XXXW	□	□	□
Panel Mount	Product Type C - Enclosed	Output Voltage	Output Power	Phase Input 1 - Single Phase, Wide Range Input Voltage 2 - Single Phase, High Line Input Voltage	A - No PFC B - With PFC N - NEC Class 2	Connector Type A - Terminal Block ³⁾ J - IP20 Connector ¹⁾ L - Front Face ²⁾ H - Harness ¹⁾
PM	C –	D	SPV	100W	1	A
Panel Mount	Product Type C - Enclosed	Dual Output	Output Voltage S - 24V P - 5V	Output Power	Phase Input 1 - Single Phase	Delta Standard

1) Options

2) Options for 150W with PFC

3) For PMC-05V015W1AA and PMC-□V600W1BA, the connector type is a Front Face connector.
For PMC-24V300W1BA, the connector type is an IP20 connector.

PM	H –	XXV	XXXW	C	□	□
Panel Mount	Product Series H - Household Series	Output Voltage	Output Power	Package Type C - Enclosed	Pollution Degree 2 A - No PFC B - With PFC Pollution Degree 3 C - No PFC D - With PFC L - Low Profile M - Low Profile with NEC Class 2 N - NEC Class 2	Output Non-Isolated to PE (PELV) A - Terminal Block J - IP20 connector L - Front Face H - Harness Output Isolated to PE (SELV) S - Terminal Block U - IP20 Connector V - Front Face T - Harness

PRODUCT SELECTION GUIDE

| Industrial Power Supplies

New products are frequently introduced. Please visit www.DeltaPSU.com for latest product updates.

Product Type	Series	Model Name	Phase		Output Voltage	Output Current	Output Power	Input Voltage Range	Page	
			1	PFC						
Panel Mount Power Supply	PMF • Remote ON/OFF • Built-in PFC	PMF-4V320WC□□	•	•	4.2V	55.0A	231W	85-264Vac	62	
		PMF-5V320WC□□	•	•	5V	55.0A	275W			
		PMF-24V200WC□□	•	•	24V	8.4A	200W			
		PMF-24V240WC□□	•	•		10.0A	240W			
		PMF-24V320WC□□	•	•		13.3A	320W			
	PMR • Thickness < 1U • Built-in PFC	PMR-4V320WC□A	•	•	4.2V	60.0A	252W	88-264Vac	63	
		PMR-4V320WDAA	•	•		60.0A	252W			
		PMR-4V320WDGA	•	•		60.0A	252W			
		PMR-4V320WDBA	•	•		60.0A	252W			
		PMR-4V320WDCA	•	•	5V	60.0A	252W			
		PMR-5V320WC□A	•	•		60.0A	300W			
		PMR-5V320WDAA	•	•		60.0A	300W			
		PMR-5V320WDGA	•	•		60.0A	300W			
	PMU • Power supply with integrated DC-UPS	PMU-13V155W□BA	•	•	13.8V	V1: 9.5A B+: 1.5A	151W	90-132Vac, 180-264Vac (Selectable by Switch)	65	
		PMU-13V155W□CA	•	•			151W			
		PMU-27V155W□BA	•	•	27.6V	Enclosed L Frame	V1: 4.0A, B+: 1.5A			151W
		PMU-27V155W□CA	•	•			V1: 4.3A, B+: 1.2A			151W

Panel Mount Power Supply Model Numbering

PM	F –	XXV	XXXW	C	□	□
Panel Mount	Product Series F - PFC Series	Output Voltage	Output Power	Package Type C - Enclosed	Connector Type G - Front Face A - Terminal Block ¹⁾	Variable B - No Remote ON/OFF R - With Remote ON/OFF ¹⁾

1) Options

PM	R –	XXV	XXXW	□	□	□
Panel Mount	Product Series R - Standard Rack Type Series (1U)	Output Voltage	Output Power	Package Type C - Enclosed with Fan D - Enclosed without Fan	Connector Type A - Terminal Block B - Terminal Block (Parallel Operation) ²⁾ G - Front Face ¹⁾ C - Front Face (Parallel Operation) ²⁾	Variable A - With conformal coating

1) Options

2) Options for Enclosed without Fan (PMR-□V320WDBA and PMR-□V320WDCA)

PM	U –	XXV	XXXW	□	□	A
Panel Mount	Product Series U - With DC UPS Function	Output Voltage	Output Power	Package Type C - Enclosed L - L Frame ¹⁾	Signal B - Without Signal C - With Signal	Connector Type A - Terminal Block

1) Options

Industrial Power Supplies

New products are frequently introduced. Please visit www.DeltaPSU.com for latest product updates.

Product Type	Series	Model Name	Phase		Output Voltage	Convection		Forced Air		Input Voltage Range	Page			
			1	PFC		Output Current	Output Power	Output Current	Output Power					
Open Frame Power Supply	PJT	PJT-12V40WBAA	•		12V	3.33A	40W			90-264Vac	68			
		PJT-12V65WBAA	•			5.0A	60W							
		PJT-12V100WBAA	•	•		8.33A	100W							
		PJT-12V100WBBA	•		6.67A	80W	8.33A	100W						
		PJT-15V40WBAA	•		15V	2.67A	40W					90-264Vac	69	
		PJT-15V65WBAA	•			4.2A	63W							
		PJT-15V100WBAA	•	•		6.67A	100W							
		PJT-15V100WBBA	•		5.33A	80W	6.67A	100W						
		PJT-18V40WBAA	•		18V	2.22A	40W				90-264Vac			70
		PJT-18V65WBAA	•			3.61A	65W							
		PJT-18V100WBAA	•	•		5.55A	100W							
		PJT-18V100WBBA	•		4.44A	80W	5.55A	100W						
	PJT-24V40WBAA	•		24V	1.66A	40W			90-264Vac	71				
	PJT-24V65WBAA	•			2.71A	65W								
	PJT-24V100WBAA	•	•		4.17A	100W								
	PJT-24V100WBBA	•		3.33A	80W	4.17A	100W							
	PJT-27V150WBNA	•	•	V1: 27V V _{SB} : 12V	V1: 5.55A V _{SB} : 0.5A	150W					85-264Vac			
	PJ	PJ-12V15W□□NA	•		12V	1.3A	15.6W					85-264Vac	72	
PJ-12V30W□□NA			•			2.5A	30W							
PJ-12V50W□□NA			•	•		4.3A	51.6W							
PJ-12V100W□□□A			•	•	8.5A	102W								
PJ-12V150W□□□A			•	•	12.5A	150W								
PJ-24V30W□□NA			•		24V	1.25A	31.2W			85-264Vac	73			
PJ-24V50W□□NA		•	•	2.1A		50.4W								
PJ-24V100W□□□A		•	•	4.3A		103.2W								
PJ-24V150W□□□A		•	•	6.3A	150W									
PJ-5V15W□□NA		•		5V	3.0A	15W			85-264Vac			74		
PJ-48V50W□□NA	•	•	48V	1.1A	52.8W									
PJB	PJB-24V100W□□□A	•	•	24V	4.3A	103.2W			85-264Vac	75				
		PJB-24V150W□□□A	•		•	6.3A	151.2W							
		PJB-24V240W□□□A	•		•	10.0A	240W							
		PJB-24V300W□□□A	•		•	12.5A	300W							

Open Frame Power Supply Model Numbering

PJ	T –	XXV	XXXW	B	□	□
Open Frame	Product Series T - ITE Application Series	Output Voltage	Output Power	Package Type B - Open Frame	A - Family Code B - Family Code N - No Remote ON/OFF	Connector Type A - JST connector B - Molex connector ¹⁾ C - JWT connector ¹⁾

1) Options

PJ –	XXV	XXXW	□	□	A
Open Frame	Output Voltage	Output Power	Package Type C - Enclosed L - L Frame ¹⁾ B - Open Frame ¹⁾	Remote ON/OFF Function N - No Remote ON/OFF R - With Remote ON/OFF ²⁾	Delta Standard

1) Options

2) Options for 100W and above

PJ	B –	XXV	XXXW	□	□	A
Open Frame	Product Series B - Power Boost Series	Output Voltage	Output Power	Package Type C - Enclosed L - L Frame ¹⁾ B - Open Frame ¹⁾ Green Mode ²⁾ G - Enclosed H - L Frame ¹⁾ J - Open Frame ¹⁾	Remote ON/OFF Function N - No Remote ON/OFF R - With Remote ON/OFF ¹⁾	Connector Type A - Harness

1) Options

2) Green Mode is available for 150W only

PRODUCT SELECTION GUIDE

| Industrial Power Supplies

New products are frequently introduced. Please visit www.DeltaPSU.com for latest product updates.

Product Type	Series	Model Name	Phase	PFC	Output Voltage	Output Current	Convection	Forced Air	Input Voltage Range	Page
			1				Output Power			
Open Frame Power Supply	PJH • Household and ITE safety approvals	PJH-24V300WBB□	•	•	V1: 24V V _{SB} : 5V	V1: 12.5A V _{SB} : 1.2A	240W	300W	90-264Vac	76
		PJH-24V300WBC□	•	•	V1: 24V V _{SB} : 12V	V1: 12.5A V _{SB} : 0.5A	240W	300W		
		PJH-36V300WBB□	•	•	V1: 36V V _{SB} : 5V	V1: 8.3A V _{SB} : 1.2A	240W	300W		
		PJH-36V300WBC□	•	•	V1: 36V V _{SB} : 12V	V1: 8.3A V _{SB} : 0.5A	240W	300W		
	PJU • Power supply with integrated DC-UPS • Compact size	PJU-13V60W□A□	•		V1: 13.8V B+: 13.6V	V1: 3.9A B+: 0.4A	60W		90-264Vac	77
		PJU-13V60W□B□	•			V1: 3.9A B+: 0.4A	60W			
		PJU-27V60W□A□	•		V1: 27.6V B+: 12.4V	V1: 1.75A B+: 0.4A	60W			
		PJU-27V60W□B□	•			V1: 1.75A B+: 0.4A	60W			
	PJL • UL 8750 and IEC/UL 60950-1 approvals • Low inrush current • LED lighting power solution	PJL-48V200WBAA	•	•	48V	4.17A	150W	200W	85-305Vac	78
		PJL-48V400WBAA	•	•		8.33A	200W	400W		

Open Frame Power Supply Model Numbering

PJ	H –	XXV	XXXW	B	□	□
Open Frame	Product Type H - Household Series	Output Voltage	Output Power	Package Type B - Open Frame	Voltage Standby B - 5V ¹⁾ C - 12V	Connector Type A - JST connector B - Molex connector ¹⁾ C - JWT connector ¹⁾

1) Options

PJ	U –	XXV	XXXW	□	□	□
Open Frame	Product Series U - With DC-UPS Function	Output Voltage	Output Power	Package Type C - Enclosed L - L Frame ¹⁾ B - Open Frame ¹⁾	Signal A - Without Signal ¹⁾ B - With Signal	Connector Type A - Terminal Block B - JST connector ¹⁾ C - Molex connector ¹⁾

1) Options

PJ	L –	XXV	XXXW	B	A	A
Open Frame	Product Type L - Lighting Application Series	Output Voltage	Output Power	Package Type B - Open Frame	Active PFC	A - TE connector

Industrial Power Supplies

New products are frequently introduced. Please visit www.DeltaPSU.com for latest product updates.

Product Type	Series	Model Name	Output Voltage	Output Current	Input Current	Input Voltage Range	Page
Redundancy Module	CliQ II	DRR-20□	22-60V	20.0A	(1+1 Redundancy) = Nominal 2 × 12.5A (N+1 Redundancy) = Nominal 2 × 10A	22-60Vdc	80
		DRR-40□		40.0A	(1+1 Redundancy) = Nominal 2 × 25A (N+1 Redundancy) = Nominal 2 × 20A		
Buffer Module	CliQ II	DRB-24V020AB□	24V	20.0A	Charging Mode: < 0.6A	22.8-28.8Vdc	81
		DRB-24V040ABN		40.0A	Charging Mode: < 0.6A		
DC-UPS Module	CliQ II	DRU-24V40ABN	24V	40.0A	Charging Mode: 2.0A ± 1.0A	24-28Vdc	82
	Chrome	DRU-24V10ACZ		10.0A	Charging Mode: 0.5A ± 0.1A		83

Redundancy Module Model Numbering

DR	R –	XX	□
DIN Rail	Product Type R - Redundancy Module	Output Current 20 - 20A 40 - 40A	A - Metal Case, with Class I, Div 2 N - Metal Case, without Class I, Div 2

DC-UPS Module and Buffer Module Model Numbering

DR	□ –	24V	XXXA	□	□
DIN Rail	Product Type U - DC-UPS Module B - Buffer Module	Output Voltage	Output Current	B - CliQ II Series C - Chrome Series	A - Metal Case, with Class I, Div 2 N - Metal Case, without Class I, Div 2 Z - Plastic Case, without Class I, Div 2

Product Type	Series	Model Name	CC Code	AC Inlet	Output Voltage	Output Current	Output Power	Page
Adapter	ADT • Compact size • Meet energy level VI	ADT-060A12AA	B-A	C6	12V	5.0A	60W	85
		ADT-060A12AB	B-A	C8		5.0A	60W	
		ADT-060A15AA	B-A	C6	15V	4.0A	60W	
		ADT-060A15AB	B-A	C8		4.0A	60W	
		ADT-060A19AA	B-A	C6	19V	3.2A	60.8W	
		ADT-060A19AB	B-A	C8		3.2A	60.8W	
		ADT-060A24AA	B-A	C6	24V	2.5A	60W	
		ADT-060A24AB	B-A	C8		2.5A	60W	

Adapter Model Numbering

							CC Code	
ADT –	XXX	A	□	A	□	B-	A	
Delta AC-DC Adapter	Output Power 060 - 60W	Family Code A	Output Voltage (Single Output) 12 - 12V 15 - 15V 19 - 19V 24 - 24V	Package Type A - Desktop Adapter	Input Connector Type A - C6 (Class II with functional earth) B - C8	Barrel Type 5.5 × 2.1 × 10 mm, 180°	Delta Standard	

PRODUCT SELECTION GUIDE

| Medical Power Supplies

New products are frequently introduced. Please visit www.DeltaPSU.com for latest product updates.

Product Type	Series	Model Name	CC Code	Input Terminal	Output Voltage	Convection		Forced Air		Page	
						Output Current	Output Power	Output Current	Output Power		
Enclosed Power Supply	MDS	MDS-200ADB12	AA	Molex 2-pin	12V	9.17A	110W	16.67A	200W	90	
		MDS-250ADB12	AA	Molex 2-pin		12.5A	150W	20.84A	250W		
		MDS-300ADB12	AA	Molex 2-pin		15.83A	190W	25.0A	300W		
		MDS-400ADB12	AA	Molex 2-pin				33.33A	400W		
		MDS-300ADB18	AA	Molex 2-pin	18V	10.55A	190W	16.66A	300W		
		MDS-200ADB24	A	Molex 2-pin	24V	5.0A	120W	8.33A	200W		91
		MDS-250ADB24	AA	Molex 2-pin		5.62A	150W	10.41A	250W		
		MDS-300ADB24	AA	Molex 2-pin		8.75A	210W	12.5A	300W		
		MDS-400ADB24	AA	Molex 2-pin				16.67A	400W		
		MDS-300ADB48	AA	Molex 2-pin	48V	4.375A	210W	6.25A	300W		
	MEB	<ul style="list-style-type: none"> Intelligent Fan Speed Control PMBus Ver 1.3 Supported 	MEB-500A24F	AA	DECA 3-pin	24V			21.0A	500W	92
			MEB-1K2A24T	AAA	Terminal block 3-pin	24V			50.0A	1,200W	93
			MEB-1K2A42T	AAA	Terminal block 3-pin	42V			28.5A	1,200W	
			MEB-1K2A48T	AAA	Terminal block 3-pin	48V			25.0A	1,200W	
Open Frame Power Supply	MDS	MDS-040APS12 B	A	JST 2-pin	12V	3.33A	40W			95	
		MDS-065APS12 B	A	JST 2-pin		5.42A	65W				
		MDS-100APS12 B	A	JST 2-pin		8.33A	100W				
		MDS-100BPS12 B	A	JST 2-pin		6.67A	80W	8.33A	100W		

Medical Power Supply Model Numbering

MDS –	XXX	□	□	□	□	□□
Delta Medical Power Supply MDS-200A series MDS-250A series MDS-300A series MDS-400A series	Max power wattage in the product series. May be lower at some conditions. 200 - 200W 250 - 250W	Family Code A	Product Type D - Enclosed P - Open Frame	Input Type A, C, E, G - Class II 2-pin connector B, D, F, H - Class I 3-pin connector	Output Voltage 12 - 12V 24 - 24V	CC Code For DC connector, label, etc. A - DC connector type ¹⁾

ME	B –	XXX	□	□□	□	□□□
Delta Medical Power Supply	B - Enclosed	Max power wattage in the product series. May be lower at some conditions. 500 - 500W 1K2 - 1,200W	Family Code A	Output Voltage 24 - 24V 42 - 42V 48 - 48V	Inlet Type T - Terminal F - Front Face	CC Code ¹⁾

MDS –	XXX	□	□	□	□	□	□
Delta Medical Power Supply MDS-040APS series MDS-065APS series MDS-100APS series MDS-100BPS series MDS-400AUS series	Max power wattage in the product series. May be lower at some conditions. 040 - 40W 065 - 65W	Family Code A - Family A B - Family B	Product Type P - Open Frame U - U Frame	Input Type Code S - Single Output	Output Voltage 12 - 12V 24 - 24V	Input Configuration B - Class I 3-pin connector A - Class II 2-pin connector	CC Code For DC connector, label, etc. A - DC connector ¹⁾

1) Refer to technical datasheet or product catalog

Medical Power Supplies

New products are frequently introduced. Please visit www.DeltaPSU.com for latest product updates.

Product Type	Series	Model Name	CC Code	Input Terminal	Output Voltage	Convection		Forced Air		Page
						Output Current	Output Power	Output Current	Output Power	
Open Frame Power Supply	MDS	MDS-200APB12*	AA	Molex 2-pin	12V	10.83A	130W	16.67A	200W	96
		MDS-250APB12*	AA	Molex 2-pin		12.5A	150W	20.84A	250W	
		MDS-300APB12*	AA	Molex 2-pin		18.33A	220W	25.0A	300W	
		MDS-400APB12*	AA	Molex 2-pin				33.33A	400W	
		MDS-040APS15 B	A	JST 2-pin	15V	2.67A	40W			97
		MDS-065APS15 B	A	JST 2-pin		4.2A	63W			
		MDS-100APS15 B	A	JST 2-pin		6.67A	100W			
		MDS-100BPS15 B	A	JST 2-pin		5.3A	80W	6.7A	100W	
		MDS-040APS18 B	A	JST 2-pin	18V	2.22A	40W			98
		MDS-065APS18 B	A	JST 2-pin		3.61A	65W			
		MDS-100APS18 B	A	JST 2-pin		5.55A	100W			
		MDS-100BPS18 B	A	JST 2-pin		4.4A	80W	5.5A	100W	
		MDS-300APB18*	AA	Molex 2-pin		12.22A	220W	16.66A	300W	
		MDS-400AUS19 B	A	DECA 3-pin	19V	15.8A	300W	21.1A	400W	99
		MDS-400AUS24 B	A	DECA 3-pin	24V	12.5A	300W	16.67A	400W	
		MDS-400AUS30 B	A	DECA 3-pin	30V	11.67A	350W	13.33A	400W	
		MDS-040APS24 B	A	JST 2-pin	24V	1.67A	40W			100
		MDS-065APS24 B	A	JST 2-pin		2.71A	65W			
		MDS-100APS24 B	A	JST 2-pin		4.17A	100W			
		MDS-100BPS24 B	A	JST 2-pin		3.3A	80W	4.2A	100W	
		MDS-200APB24*	AA	Molex 2-pin		5.83A	140W	8.33A	200W	101
		MDS-250APB24*	AA	Molex 2-pin		6.25A	150W	10.41A	250W	
		MDS-300APB24*	AA	Molex 2-pin		10.0A	240W	12.5A	300W	
		MDS-400APB24*	AA	Molex 2-pin		8.33A	200W	16.66A	400W	
	MDS-300APB48*	AA	Molex 2-pin	48V	5.0A	240W	6.25A	300W		
	MDS-100AP401 B	A	Molex 2-pin	5.1V/12V/ -15V/15V	4A/2A/ 0.6A/0.8A	65W	8A/3A/ 0.8A/0.8A	100W	102	
		MEP • High MTBF • Low touch current	MEP-25A15J	BNA	JWT 2-pin	15V	1.67A	25W		103
			MEU • PMBus Ver 1.3 Supported	MEU-600C24T	AAA	DINKLE 3-pin	24V	25.0A	600W	
		MEU-600C48T		AAA	DINKLE 3-pin	48V	12.5A	600W		

* Product with options for enclosed or open frame

Medical Power Supply Model Numbering

MDS –	XXX	□	□	□	□	□
Delta Medical Power Supply MDS-100AP401	Max power wattage in the product series. May be lower at some conditions. 100 - 100W	Family Code A	Product Type P - Open Frame	Output Voltage 401 - 5.1V, 12V, -15V, 15V	Input Configuration B - Class I with PE connection	CC Code For DC connector, label, etc. A - DC connector ¹⁾

1) Refer to technical datasheet or product catalog

ME	P –	XX	□	□	□	□□□
Delta Medical Power Supply	P - Open Frame	Max power wattage in the product series. May be lower at some conditions. 25 - 25W	Family Code A	Output Voltage 15 - 15V	Input Connector J - Harness	CC Code

ME	U –	XXX	□	□	□	□□□
Delta Medical Power Supply	U - U Frame	Max power wattage in the product series. May be lower at some conditions. 600 - 600W	Family Code C - Family C	Output Voltage 24 - 24V 48 - 48V	Inlet Type T - Terminal	CC Code

PRODUCT SELECTION GUIDE

| Medical Power Supplies

New products are frequently introduced. Please visit www.DeltaPSU.com for latest product updates.

Product Type	Series	Model Name	CC Code	AC Inlet	Output Voltage	Output Current	Output Power	Page
ATX Power Supply	MDS	MDS-350AD701	AA	C14	+3.3V, +5V, +5V _{SB} , +12V ₁ , +12V ₂ , -12V, -5V	8A, 9A, 1.25A, 8A, 8A, 0.25A, 0.1A	350W	106

Product Type	Series	Model Name	Output Slots	Output Voltage	Output Power	Page
Configurable Power Supply	MEG • PMBus Ver 1.3 Supported • IT & Medical safety approvals	MEG-1K2A4	4 Slots	Single Output: 2V-60V	1,200W	108
		MEG-2K1A6	6 Slots		2,100W	

Product Type	Series	Model Name	CC Code	AC Inlet	Output Voltage	Output Current	Output Power	Page	
Adapter	MDS	MDS-005AAS05 A	R	Wall mount-China type	5V	1.00A	5W	110	
		MDS-005AAS05 B	R	Wall mount-Japan, USA type		1.00A	5W		
		MDS-005AAS05 C	R	Wall mount-EU type		1.00A	5W		
		MDS-030AAC05*		Duck Head	3.00A	15W			
		MDS-005AAS06 A	R	Wall mount-China type	6V	0.83A	5W		
		MDS-005AAS06 B	R	Wall mount-Japan, USA type		0.83A	5W		
		MDS-005AAS06 C	R	Wall mount-EU type		0.83A	5W		
		MDS-030AAC07*		Duck Head	7V	3.00A	21W		
		MDS-030AAC12*		Duck Head		2.00A	24W		
		MDS-060AAS12 B	A	C14	12V	5.00A	60W		111
		MDS-060BAS12 A	B	C8		5.00A	60W		
		MDS-080AAS12 A		C8		6.66A	80W		
		MDS-150AAS12 B	A	C14		10.00A	120W		

* Please refer to technical datasheet to get detailed information

Medical Power Supply Model Numbering

MDS –	XXX	□	□	□	□□
Delta Medical Power Supply MDS-350AD701	Max power wattage in the product series. May be lower at some conditions. 350 - 350W	Family Code A	Product Type D - Enclosed	Output Voltage 701 - +3.3V, +5V, +5V _{SB} , +12V ₁ , +12V ₂ , -12V, -5V	CC Code

ME	G –	XXX	A	□
Delta Medical Power Supply	G - Configurable	Max power wattage in the product series. May be lower at some conditions. 1K2 - 1,200W 2K1 - 2,100W	Family Code A	Slot Number 4 - 4 Slots 6 - 6 Slots

MDS –	XXX	□	□	□	□	□□	
Delta Medical Power Supply MDS-005AAS series MDS-060AAS series MDS-060BAS series MDS-080AAS series MDS-090AAS series MDS-090BAS series MDS-150AAS series	Max power wattage in the product series. May be lower at some conditions. 005 - 5W 060 - 60W	Family Code A - Family A B - Family B	Product Type A - Adapter	# of Output S - Single Output	Output Voltage 12 - 12V 24 - 24V	Input Configuration A - C8 B - C14 C - NA For 005AAS A - CN B - US C - EU	CC Code For DC plug, cable length, label, etc.

Medical Power Supplies

New products are frequently introduced. Please visit www.DeltaPSU.com for latest product updates.

Product Type	Series	Model Name	CC Code	AC Inlet	Output Voltage	Output Current	Output Power	Page	
Adapter	MDS	MDS-030AAC15*		Duck Head	15V	2.00A	30W	112	
		MDS-060AAS15 B	A	C14		4.00A	60W		
		MDS-090AAS15 B	A	C14		6.00A	90W		
		MDS-060AAS19 B	A	C14	19V	3.20A	60W	113	
		MDS-060BAS19 A	A	C8		3.15A	60W		
		MDS-090AAS19 B	A	C14		4.74A	90W		
		MDS-150AAS19 B	A	C14		7.89A	150W		
		MDS-150CAB19	AA	C6	7.90A	150W			
		MDS-030AAC24*		Duck Head	24V	1.25A	30W	114	
		MDS-060AAS24 B	A	C14		2.50A	60W		
		MDS-060BAS24 A	A	C8		2.50A	60W		
		MDS-090AAS24 B	A	C14	3.75A	90W	115		
		MDS-090BAS24 A	B	C8	3.75A	90W			
	MDS-150AAS24 B	A	C14	6.25A	150W				
	MEA	<ul style="list-style-type: none"> Efficiency Level VI 2 × MOPP isolation 	MEA-065A12C	A-A	C14	12V	5.0A	60W	116
			MEA-120A15B	G-A	C8	15V	8.0A	120W	
			MEA-065A24C	A-A	C14	24V	2.71A	65W	
			MEA-250A24C	H-A	C14	10.42A	250W		
	MEF	<ul style="list-style-type: none"> IP22 ingress protection rating 2 × MOPP isolation 	MEF-010A05B	J-A	Wall mount-US type	5V	2.0A	10W	117

* Please refer to technical datasheet to get detailed information

Medical Power Supply Model Numbering

MDS –	XXX	□	□	□	□□	□□
Delta Medical Power Supply MDS-150CAB19A	Max power wattage in the product series. May be lower at some conditions. 150 - 150W	Family Code C	Product Type A - Adapter	Input Connector Type A, C, E, G - Class II C8/C18 B, D, F, H - Class I C6/C14	Output Voltage 19 - 19V	CC Code AA-ZX Power cord length, plug, label, etc.
MDS –	XXX	AAC	□	□	□□	□
Delta Medical Power Supply MDS-030 series	Max power wattage in the product series. May be lower at some conditions. 030 - 30W	Family Code	Output Voltage (Single Output) 05 - 5V 07 - 7V 12 - 12V 15 - 15V ¹⁾ 24 - 24V	CC Code DC plug type and output cable length A - 2.1 × 5.5 × 10 mm DC plug, and 1200 mm cable length B - 2.1 × 5.5 × 12 mm DC plug, and 1200 mm cable length ²⁾	Country Duck Head Type A - China B - United States ²⁾ C - European ²⁾ D - UK ²⁾ E - Australia ²⁾ G - Korea ²⁾ H - India ²⁾ J - Argentina ²⁾ K - Brazil ²⁾ M - South Africa ²⁾	

1) MDS-030AAC15 BB is not available

2) Options

ME	A –	XXX	□	□□	□	□□
Delta Medical Power Supply	A - Desktop Adapter	Max power wattage in the product series. May be lower at some conditions. 065 - 65W 120 - 120W 250 - 250W	Family Code A	Output Voltage 12 - 12V 15 - 15V 24 - 24V	Input Connector Type B - Class II C8 C - Class I C14	CC Code For DC plug, cable length, label, etc.

ME	F –	XXX	□	□□	B	□□
Delta Medical Power Supply	F - Fixed	Max power wattage in the product series. May be lower at some conditions. 010 - 10W	Family Code A	Output Voltage 05 - 5V	Country Duck Head Type B - United States (2-pin)	CC Code For DC plug, cable length, label, etc.

Industrial Power Supplies

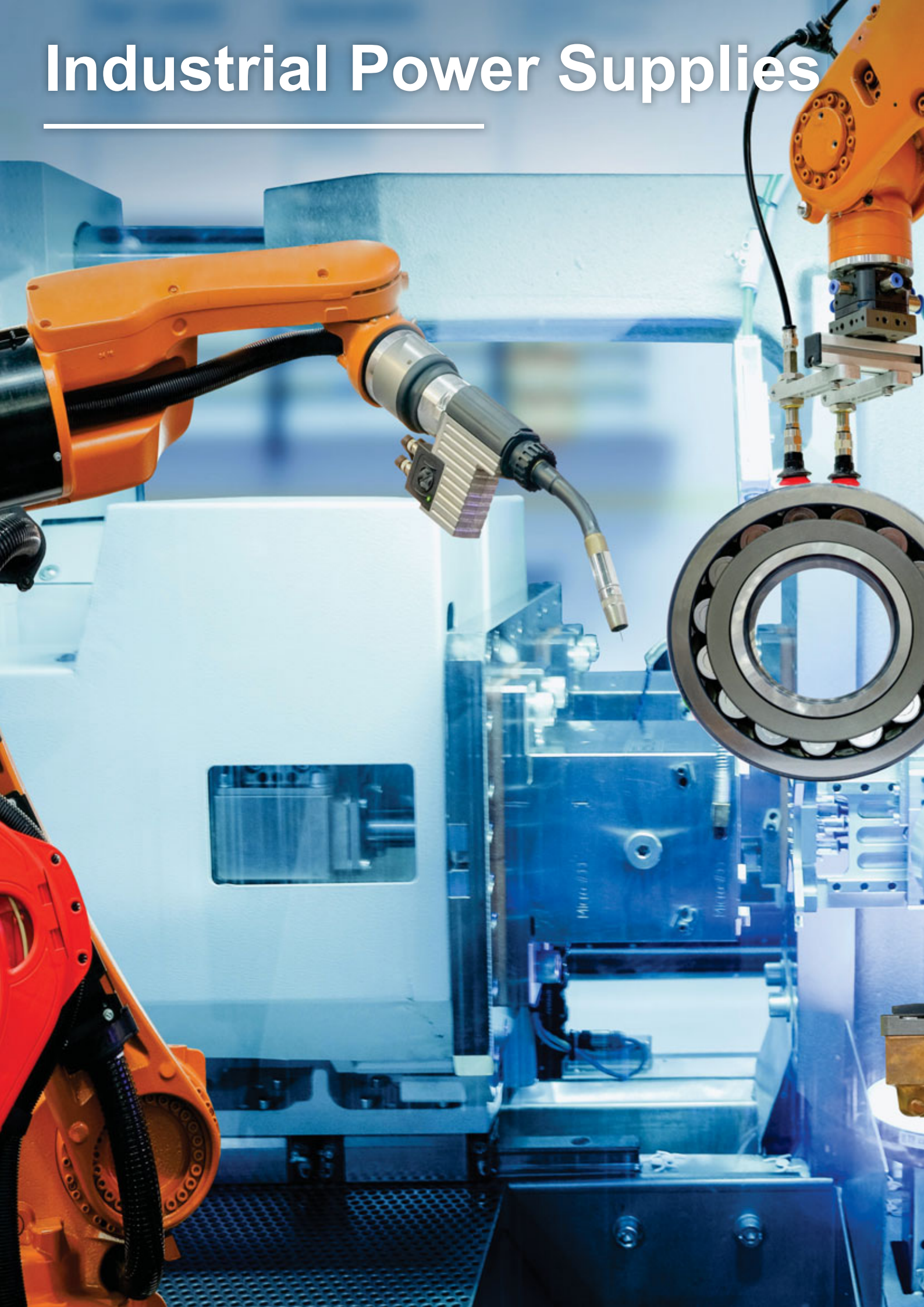

PRODUCT OVERVIEW

Delta standard industrial power supplies comprise of DIN rail, panel mount and open frame types. With over 40 years of experience in power technologies, Delta delivers an extensive range of industrial power supplies that meet IEC 62368-1, IEC 61347-2-13, UL 8750, IEC 60335-1, IEC 61558-1, IEC 61558-2-16 and many other more standards.



DIN Rail

Delta's feature-rich DIN rail power supplies offers start-up at -40°C , Advanced Power Boost (CliQ M & CliQ VA) and smart monitoring function (CliQ VA) for demanding applications.



Panel Mount

Delta offers many series of panel mount power supplies for different needs. The latest PMT2 series with slim form factor at competitive prices for general industrial applications. The PMH series with household electrical appliances safety approvals.



Open Frame

The open frame power supplies offers varieties of nominal output voltage with versatile configuration options. The latest PJL series comes with lighting approvals such as UL 8750 and IEC 61347-2-13.



Modules

The DIN rail modules are useful accessories to enhance your power management solution. The modules include UPS, buffer and redundancy modules which are designed to work seamlessly with Delta DIN rail power supplies.



Adapter

The ADT adapter series offers efficiency up to 89% with extreme no load consumption below 0.15W. These adapters are also compliant with DoE level VI and ErP Lot 7 efficiency standards.

INDUSTRIAL POWER SUPPLIES

| DIN Rail Power Supply



AR

CliQ™

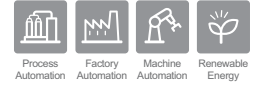

- Power will not de-rate for the entire input voltage range
- Power Boost of 150% for 3 seconds (24V/480W: 200% for 2 seconds)
- Full corrosion resistant aluminium casing for selected models
- Hazardous Locations approval to ATEX and Class I, Div 2 for selected models
- Conformal coating on PCBAs to protect against common dust and chemical pollutants (except DRP-24V48W1AZ and DRP024V060W1AZ)



AR

CliQ™

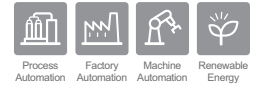

- Power will not de-rate for the entire input voltage range
- Power Boost of 150% for 5 seconds (24V/480W: 200% for 2 seconds)
- Full corrosion resistant aluminium casing (except DRP024V060W1N□)
- Cold start -40°C for selected models
- Hazardous Locations approval to ATEX and Class I, Div 2 for selected models



AR

CliQ™

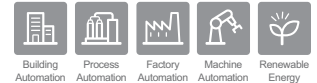

- Built-in constant current circuit for charging application
- Power Boost of 150% for 5 seconds
- SEMI F47 compliance at 120Vac
- Cold start at -40°C
- Built-in DC OK relay contact



AR

CliQ™

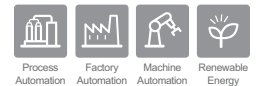

- Power Boost of 150% up to 7 seconds
- Advanced Power Boost (APB)
- DNV GL and ABS approvals for maritime applications
- Built-in DC OK contact and LED indicator for DC OK/ Over Load
- Built-in active PFC with up to 94% efficiency



AR

CliQ™^{VA}

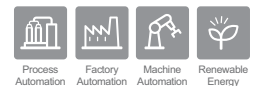

- LCD display monitoring the output current / voltage / peak current and temperature
- Life time expectancy alarm signal and monitoring
- Power Boost of 150% up to 7 seconds
- Advanced Power Boost (APB)
- Built-in active PFC with up to 94% efficiency



AR

LYTE

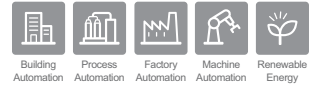

- Slim form factor
- Built-in constant current circuit for reactive loads
- Built-in DC OK relay contact (optional)
- Compliance to SEMI F47 @ 200Vac
- 15kV Air Discharge & 8kV Contact Discharge ESD immunity



AR

CHROME

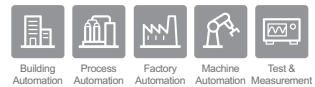

- Class II Double Isolation (No earth connection is required)
- Power will not de-rate for the entire input voltage range
- NEC Class 2 and Limited Power Source (LPS) approvals (except 12V/100W)
- Safety approval according to IEC/EN/UL 60950-1 (ITE standard) and UL 508 (Industrial standard)
- Full power up to 55°C



AR

SYNC

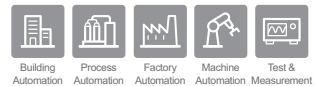

- Low earth leakage current < 0.5mA @ 264Vac
- Built-in DC OK relay contact (optional)
- Cold start at -40°C
- Full power from -10°C to 55°C operation
- NEC Class 2 / Limited Power Source (LPS) certified



Features

- Universal AC input voltage range
- Power will not de-rate for the entire input voltage range
- Power Boost of 150% for 3s
- Full corrosion resistant aluminium casing for 12V/60W and 12V/100W
- Conforms to harmonic current IEC/EN 61000-3-2, Class A
- Multiple wire connections to terminals allowed
- Conformal coating on PCBAs to protect against common dust and chemical pollutants
- Hazardous Locations approval to ATEX and Class I, Div 2

Specifications

OUTPUT	DRP012V015W1A□	DRP012V030W1A□	DRP012V060W1AA	DRP012V100W1AA	
Output Voltage	12V	12V	12V	12V	
Output Voltage Range	11-14V	11-14V	11-14V	11-14V	
Output Current	0-1.25A	0-2.5A	0-5.0A	0-8.33A	
Output Power	15W	30W	60W	100W	
PARD (20MHz)	< 100mVpp				
Hold-up Time	115Vac > 22ms	> 22ms	> 22ms	> 22ms	
	230Vac > 110ms	> 110ms	> 110ms	> 110ms	
INPUT					
Phase Input	Single Phase				
Input Voltage Range	85-264Vac (DC input range 120-375Vdc) ¹⁾				
Input Frequency	47-63Hz				
Input Current	115Vac < 0.37A	< 0.70A	< 1.35A	< 2.50A	
	230Vac < 0.22A	< 0.42A	< 0.80A	< 1.50A	
Efficiency ²⁾ at 100% Load	115Vac > 84.0%	> 85.0%	> 86.0%	> 85.5%	
	230Vac > 83.0%	> 85.0%	> 86.0%	> 87.5%	
Max Inrush Current (Cold Start)	115Vac < 30A	< 40A	< 50A	< 100A	
	230Vac < 65A	< 80A	< 100A	No Damage	
Power Factor	Conform to EN 61000-3-2				
Leakage Current	240Vac < 1mA	< 1mA	< 1mA	< 1mA	
MECHANICAL					
Case Cover / Chassis	Plastic		Aluminium		
Dimensions (L × W × D)	mm	100 × 32 × 100.6	100 × 32 × 100.6	121 × 32 × 120	121 × 50 × 118.7
	inch	3.94 × 1.26 × 3.96	3.94 × 1.26 × 3.96	4.76 × 1.26 × 4.72	4.76 × 1.97 × 4.67
Unit Weight	kg	0.18	0.20	0.33	0.64
	lb	0.40	0.44	0.73	1.41
Cooling System	Convection				
MTBF ³⁾	> 500,000 hrs	> 500,000 hrs	> 500,000 hrs	> 500,000 hrs	
ENVIRONMENT					
Operating Temperature ⁴⁾	-20°C to +80°C				
Storage Temperature	-25°C to +85°C				
Operating Humidity	5 to 95% RH (Non-Condensing)				
Operating Altitude	0 to 2,000 m (0 to 6,560 ft)				

Dimensions Reference

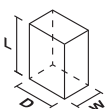

Notes

- 1) All models are certified for DC input.
- 2) At 25°C ambient temperature by vertical mounting orientation.
- 3) MTBF as per Telcordia SR-332 (Confidence level: 90%, I/P: 115Vac, O/P: 100% load) for vertical mounting orientation.
- 4) Refer power de-rating in the product datasheet.
- 5) All parameters are specified at 25°C ambient temperature unless otherwise indicated.



Features

- Universal AC input voltage range
- Power will not de-rate for the entire input voltage range
- Power Boost of 150% for 3s (480W: 200% for 2s)
- Full corrosion resistant aluminium casing
- SEMI F47 Certified for selected models
- Conforms to harmonic current IEC/EN 61000-3-2, Class A
- Conformal coating on PCBAs to protect against common dust and chemical pollutants*
- Hazardous Locations approval to ATEX and Class I, Div 2*

*Except DRP-24V48W1AZ and DRP024V060W1AZ



Specifications

OUTPUT		DRP-24V48W1AZ	DRP024V060W1AZ	DRP024V060W1AA	DRP024V120W1AA	DRP024V240W1AA	DRP024V480W1AA
Output Voltage		24V	24V	24V	24V	24V	24V
Output Voltage Range		22-26V	22-28V	22-28V	22-28V	22-28V	22-28V
Output Current		0-2.0A	0-2.5A	0-2.5A	0-5.0A	0-10.0A	0-20.0A
Output Power		48W	60W	60W	120W	240W	480W
PARD (20MHz)		< 480mVpp		< 240mVpp			
Hold-up Time	115Vac	> 10ms	> 20ms	> 20ms	> 35ms	> 20ms	> 20ms
	230Vac	> 60ms	> 125ms	> 125ms	> 70ms		
INPUT							
Phase Input	Single Phase						
Input Voltage Range	85-264Vac (DC input range 120-375Vdc) ¹⁾						
Input Frequency	47-63Hz						
Input Current	115Vac	< 1.4A	< 1.1A	< 1.1A	< 1.4A	< 2.9A	< 5.7A
	230Vac	< 0.7A	< 0.7A	< 0.7A	< 0.8A	< 1.5A	< 2.8A
Efficiency ²⁾ at 100% Load	115Vac	> 86.0%	> 86.0%	> 86.0%	> 86.0%	> 89.0%	> 85.0%
	230Vac	> 87.0%	> 87.0%	> 87.0%	> 87.0%	> 91.0%	> 88.0%
Max Inrush Current (Cold Start)	115Vac	< 28A	< 40A	< 40A	< 80A	< 40A	< 50A
	230Vac	< 56A	< 80A	< 80A	< 150A	< 100A	< 150A
Power Factor	115Vac	Conform to EN 61000-3-2			> 0.98	> 0.96	> 0.97
	230Vac				> 0.87	> 0.90	> 0.95
Leakage Current	240Vac	< 1mA	< 1mA	< 1mA	< 1mA	< 1mA	< 1.25mA
MECHANICAL							
Case Cover / Chassis		Plastic			Aluminium		
Dimensions (L × W × D)	mm	100 × 32 × 100.6	120.6 × 32 × 113	121 × 32 × 120	121 × 50 × 118.7	121 × 85 × 118.5	121 × 160 × 118.5
	inch	3.94 × 1.26 × 3.96	4.75 × 1.26 × 4.45	4.76 × 1.26 × 4.72	4.76 × 1.97 × 4.67	4.76 × 3.35 × 4.67	4.76 × 6.30 × 4.67
Unit Weight	kg	0.22	0.33	0.37	0.50	1.04	1.80
	lb	0.49	0.73	0.82	1.19	2.29	3.97
Cooling System	Convection						
MTBF ³⁾		> 500,000 hrs	> 500,000 hrs	> 500,000 hrs	> 500,000 hrs	> 300,000 hrs	> 300,000 hrs
ENVIRONMENT							
Operating Temperature ⁴⁾		-20°C to +70°C		-20°C to +80°C			
Storage Temperature	-25°C to +85°C						
Operating Humidity	5 to 95% RH (Non-Condensing)						
Operating Altitude	0 to 2,000 m (0 to 6,560 ft)						

Dimensions Reference

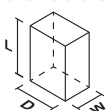

Notes

- 1) All models are certified for DC input except DRP-24V48W1AZ which still fulfills the test conditions of this range. DC input safety approval can be obtained upon request.
- 2) At 25°C ambient temperature by vertical mounting orientation.
- 3) MTBF as per Telcordia SR-332 (Confidence level: 90%, I/P: 115Vac, O/P: 100% load) for vertical mounting orientation.
- 4) Refer power de-rating in the product datasheet.
- 5) All parameters are specified at 25°C ambient temperature unless otherwise indicated.



Features

- Universal AC input voltage range
- Power will not de-rate for the entire input voltage range
- High Efficiency > 90.0% @ 230Vac
- Power Boost of 150% for 5s (480W: 200% for 2s)
- Full corrosion resistant aluminium casing
- Conforms to harmonic current IEC/EN 61000-3-2, Class A
- Extreme low temperature cold start at -40°C
- Conformal coating on PCBAs to protect against common dust and chemical pollutants
- Hazardous Locations approval to ATEX and Class I, Div 2

Specifications

OUTPUT	DRP024V060W1B□	DRP024V120W1B□	DRP024V240W1B□	DRP024V480W1B□
Output Voltage	24V	24V	24V	24V
Output Voltage Range	24-28V	24-28V	24-28V	24-28V
Output Current	0-2.5A	0-5.0A	0-10.0A	0-20.0A
Output Power	60W	120W	240W	480W
PARD (20MHz)	< 150mVpp			
Hold-up Time	115Vac	> 20ms	> 20ms	> 20ms
	230Vac	> 125ms	> 115ms	> 20ms
INPUT				
Phase Input	Single Phase			
Input Voltage Range	85-264Vac (DC input range 120-375Vdc) ¹⁾			
Input Frequency	47-63Hz			
Input Current	115Vac	< 1.4A	< 2.2A	< 2.5A
	230Vac	< 0.8A	< 1.1A	< 1.3A
Efficiency ²⁾ at 100% Load	115Vac	> 89.0%	> 89.0%	> 90.0%
	230Vac	> 90.0%	> 90.0%	> 92.0%
Max Inrush Current (Cold Start)	115Vac	< 20A	< 35A	< 35A
	230Vac	< 35A	< 35A	< 35A
Power Factor	115Vac	Conform to EN 61000-3-2		> 0.96
	230Vac			> 0.95
Leakage Current	240Vac	< 1mA	< 1mA	< 3mA
MECHANICAL				
Case Cover / Chassis	Aluminium			
Dimensions (L × W × D)	mm	121 × 32 × 125	121 × 50 × 123.1	121 × 85 × 124.1
	inch	4.76 × 1.26 × 4.92	4.76 × 1.97 × 4.85	4.76 × 3.35 × 4.89
Unit Weight	kg	0.37	0.72	1.10
	lb	0.82	1.59	2.43
Cooling System	Convection			
MTBF ³⁾	> 800,000 hrs	> 800,000 hrs	> 500,000 hrs	> 500,000 hrs
ENVIRONMENT				
Operating Temperature ⁴⁾	-25°C to +80°C			-25°C to +75°C
Storage Temperature	-40°C to +85°C			
Operating Humidity	5 to 95% RH (Non-Condensing)			
Operating Altitude	0 to 2,500 m (0 to 8,200 ft)			

Dimensions Reference

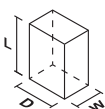

Notes

- 1) All models fulfill the test conditions for this range. DC input safety approval can be obtained upon request. While DRP024V060W1B□ is also certified for DC input.
- 2) At 25°C ambient temperature by vertical mounting orientation.
- 3) MTBF as per Telcordia SR-332 (Confidence level: 90%, I/P: 115Vac, O/P: 100% load) for vertical mounting orientation.
- 4) Refer power de-rating in the product datasheet.
- 5) All parameters are specified at 25°C ambient temperature unless otherwise indicated.



Features

- Universal AC input voltage range
- Power will not de-rate for the entire input voltage range
- UL 1310 safety approval
- NEC Class 2 and Limited Power Source (LPS) approvals
- Conforms to harmonic current IEC/EN 61000-3-2, Class A
- Conformal coating on PCBAs to protect against common dust and chemical pollutants
- Hazardous Locations approval to ATEX and Class I, Div 2 (DRP024V060W1NY)



Specifications

OUTPUT		DRP024V060W1N□	DRP-24V100W1NN
Output Voltage		24V	24V
Output Voltage Range		24-28V	22-24V
Output Current		0-2.5A	0-3.8A
Output Power		60W	91.2W
PARD (20MHz)		< 240mVpp	< 150mVpp
Hold-up Time	115Vac	> 20ms	> 20ms
	230Vac	> 125ms	> 30ms
INPUT			
Phase Input		Single Phase	
Input Voltage Range		85-264Vac (DC input range 120-375Vdc) ¹⁾	
Input Frequency		47-63Hz	
Input Current	115Vac	< 1.50A	< 1.00A
	230Vac	< 0.80A	< 0.53A
Efficiency ²⁾ at 100% Load	115Vac	> 88.0%	> 88.0%
	230Vac	> 89.0%	> 89.0%
Max Inrush Current (Cold Start)	115Vac	< 40A	< 30A
	230Vac	< 80A	< 60A
Power Factor	115Vac	Conform to EN 61000-3-2	
	230Vac	> 0.99	> 0.94
Leakage Current	240Vac	< 0.5mA	< 0.5mA
MECHANICAL			
Case Cover / Chassis		Plastic	Aluminium
Dimensions (L × W × D)	mm	120.6 × 32 × 119.3	124 × 40 × 124
	inch	4.75 × 1.26 × 4.70	4.88 × 1.57 × 4.88
Unit Weight	kg	0.33	0.60
	lb	0.73	1.32
Cooling System		Convection	
MTBF ³⁾		> 800,000 hrs	> 800,000 hrs
ENVIRONMENT			
Operating Temperature ⁴⁾		-25°C to +80°C	
Storage Temperature		-40°C to +85°C	
Operating Humidity		5 to 95% RH (Non-Condensing)	
Operating Altitude		0 to 2,500 m (0 to 8,200 ft)	

Dimensions Reference

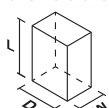

Notes

- 1) All models fulfill the test conditions for DC input. DC input safety approval can be obtained upon request.
- 2) At 25°C ambient temperature by vertical mounting orientation.
- 3) MTBF as per Telcordia SR-332 (Confidence level: 90%, I/P: 115Vac, O/P: 100% load) for vertical mounting orientation.
- 4) Refer power de-rating in the product datasheet.
- 5) All parameters are specified at 25°C ambient temperature unless otherwise indicated.



Features

- Designed for single phase input 180-305Vac (for L-N) or 2 of 3-Phase system 2 x 180-550Vac (for L-L) or 254-780Vdc
- Compact and corrosion resistant aluminium casing
- High Efficiency > 90.0%
- Conforms to harmonic current IEC/EN 61000-3-2, Class A
- Wide operating temperature range from -30°C to +70°C
- Built-in DC OK contact
- Conformal coating on PCBAs to protect against common dust and chemical pollutants



Specifications

OUTPUT		DRP-24V120W2BN	DRP-24V240W2BN
Output Voltage		24V	24V
Output Voltage Range		24-28V	24-28V
Output Current		0-5.0A	0-10.0A
Output Power		120W	240W
PARD (20MHz)		< 150mVpp	
Hold-up Time	2 x 230Vac	> 10ms	> 18ms
	2 x 400Vac	> 50ms	> 30ms
INPUT			
Phase Input	Single Phase or Two Phase		
Input Voltage Range	2 x 180-550Vac or 180-305Vac (Single Phase) (DC input range 254-780Vdc) ¹⁾		
Input Frequency	47-63Hz		
Input Current	2 x 230Vac	< 1.20A	< 2.00A
	2 x 400Vac	< 0.65A	< 1.00A
Efficiency ²⁾ at 100% Load	2 x 400Vac	> 90.0%	> 90.0%
Max Inrush Current (Cold Start)	2 x 200Vac	< 50A	< 50A
	2 x 500Vac		
Power Factor	2 x 230Vac	Conform to EN 61000-3-2	> 0.84
	2 x 400Vac		
Leakage Current	500Vac	< 3.5mA	< 3.5mA
MECHANICAL			
Case Cover / Chassis	Aluminium		
Dimensions (L x W x D)	mm	124 x 40 x 117	124 x 60 x 117
	inch	4.88 x 1.57 x 4.61	4.88 x 2.36 x 4.61
Unit Weight	kg	0.62	0.81
	lb	1.37	1.79
Cooling System	Convection		
MTBF ³⁾		> 800,000 hrs	> 500,000 hrs
ENVIRONMENT			
Operating Temperature ⁴⁾	-30°C to +70°C		
Storage Temperature	-40°C to +85°C		
Operating Humidity	5 to 95% RH (Non-Condensing)		
Operating Altitude	Industrial Application: 0 to 2,000 m (0 to 6,560 ft); ITE Application: 0 to 2,500 m (0 to 8,200 ft)		

Dimensions Reference

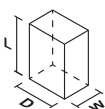

Notes

- 1) All models are certified for DC input.
- 2) At 25°C ambient temperature by vertical mounting orientation.
- 3) MTBF as per Telcordia SR-332 (Confidence level: 90%, I/P: 115Vac, O/P: 100% load) for vertical mounting orientation.
- 4) Refer power de-rating in the product datasheet.
- 5) All parameters are specified at 25°C ambient temperature unless otherwise indicated.



CLIQ^{II}

Features

- Universal AC input voltage range
- Power will not de-rate for the entire input voltage range
- Power Boost of 150% for 5s (480W: 200% for 2s)
- Full corrosion resistant aluminium casing
- Conforms to harmonic current IEC/EN 61000-3-2, Class A
- Extreme low temperature cold start at -40°C
- Conformal coating on PCBAs to protect against common dust and chemical pollutants
- Hazardous Locations approval to ATEX and Class I, Div 2 (except DRP024V960W3BN)

Specifications

OUTPUT		DRP024V060W3B□	DRP024V120W3B□	DRP024V240W3B□	DRP024V480W3B□	DRP024V960W3BN
Output Voltage		24V	24V	24V	24V	24V
Output Voltage Range		24-28V	24-28V	24-28V	24-28V	24-28V
Output Current		0-2.5A	0-5.0A	0-10.0A	0-20.0A	0-40.0A
Output Power		60W	120W	240W	480W	960W
PARD (20MHz)		< 150mVpp				< 240mVpp
Hold-up Time	3 × 400Vac	> 20ms	> 20ms	> 20ms	> 20ms	> 20ms
	3 × 500Vac	> 40ms	> 40ms	> 40ms	> 20ms	> 20ms
INPUT						
Phase Input		Two Phase or Three Phase				
Input Voltage Range (Does not exceed 600Vac)		3 × 320-600Vac or 2 × 360-600Vac (DC input range 450-800Vdc) ¹⁾				3 × 320-600Vac or 2 × 380-600Vac (DC input range 450-800Vdc) ¹⁾
Input Frequency		47-63Hz				
Input Current	3 × 400Vac	< 0.30A	< 0.50A	< 0.75A	< 1.00A	< 1.70A
	3 × 500Vac	< 0.25A	< 0.40A	< 0.65A	< 0.75A	< 1.40A
Efficiency ²⁾ at 100% Load	3 × 400Vac 3 × 500Vac	> 86.0%	> 88.0%	> 92.0%	> 91.0%	> 92.0%
Max Inrush Current (Cold Start) ³⁾	3 × 400Vac 3 × 500Vac	< 30A	< 30A	< 40A	< 50A	< 60A
Power Factor	3 × 400Vac	Conform to EN 61000-3-2			> 0.95	> 0.95
	3 × 500Vac				> 0.94	> 0.94
Leakage Current	3 × 500Vac	< 3.5mA	< 3.5mA	< 3.5mA	< 3.5mA	< 3.5mA
MECHANICAL						
Case Cover / Chassis		Aluminium				
Dimensions (L × W × D)	mm	121 × 50 × 117.3	121 × 50 × 117.3	121 × 70 × 117.3	121 × 140 × 117.3	121 × 255 × 117.3
	inch	4.76 × 1.97 × 4.62	4.76 × 1.97 × 4.62	4.76 × 2.76 × 4.62	4.76 × 5.51 × 4.62	4.76 × 10.0 × 4.62
Unit Weight	kg	0.66	0.66	0.89	1.35	2.60
	lb	1.46	1.46	1.96	2.98	5.73
Cooling System		Convection				
MTBF ⁴⁾		> 500,000 hrs	> 500,000 hrs	> 500,000 hrs	> 500,000 hrs	> 300,000 hrs
ENVIRONMENT						
Operating Temperature ⁵⁾		-25°C to +80°C				-25°C to +65°C
Storage Temperature		-40°C to +85°C				
Operating Humidity		5 to 95% RH (Non-Condensing)				
Operating Altitude		Industrial Application: 0 to 2,000 m (0 to 6,560 ft); ITE Application: 0 to 2,500 m (0 to 8,200 ft)				

Dimensions Reference

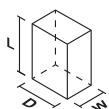

Notes

- 1) All models fulfill the test conditions for this range. DC input safety approval can be obtained upon request. While DRP024V480W3B□ and DRP024V960W3BN are also certified for DC input.
- 2) At 25°C ambient temperature by vertical mounting orientation.
- 3) AC Source capability up to 3kVA.
- 4) MTBF as per Telcordia SR-332 (Confidence level: 90%, I/P: 400Vac, O/P: 100% load) for vertical mounting orientation.
- 5) Refer power de-rating in the product datasheet.
- 6) All parameters are specified at 25°C ambient temperature unless otherwise indicated.



Features

- Universal AC input voltage range
- Power will not de-rate for the entire input voltage range
- High Efficiency > 91.0% @ 230Vac
- Power Boost of 150% for 5s
- Full corrosion resistant aluminium casing
- Conforms to harmonic current IEC/EN 61000-3-2, Class A
- Extreme low temperature cold start at -40°C
- Conformal coating on PCBAs to protect against common dust and chemical pollutants
- Hazardous Locations approval to ATEX and Class I, Div 2



Specifications

OUTPUT	DRP048V060W1B□	DRP048V120W1B□	DRP048V240W1B□	DRP048V480W1B□	
Output Voltage	48V	48V	48V	48V	
Output Voltage Range	48-56V	48-56V	48-56V	48-56V	
Output Current	0-1.25A	0-2.5A	0-5.0A	0-10.0A	
Output Power	60W	120W	240W	480W	
PARD (20MHz)	< 200mVpp				
Hold-up Time	115Vac	> 20ms	> 20ms	> 20ms	
	230Vac	> 125ms	> 50ms	> 20ms	
INPUT					
Phase Input	Single Phase				
Input Voltage Range	85-264Vac (DC input range 120-375Vdc) ¹⁾				
Input Frequency	47-63Hz				
Input Current	115Vac	< 1.4A	< 2.2A	< 5.0A	
	230Vac	< 0.8A	< 1.1A	< 3.0A	
Efficiency ²⁾ at 100% Load	115Vac	> 91.0%	> 90.0%	> 91.0%	
	230Vac	> 92.0%	> 91.0%	> 93.0%	
Max Inrush Current (Cold Start)	115Vac	< 20A	< 35A	< 35A	
	230Vac	< 35A	< 35A	< 35A	
Power Factor	115Vac	Conform to EN 61000-3-2	> 0.99	> 0.96	
	230Vac	> 0.93	> 0.90	> 0.90	
Leakage Current	240Vac	< 1mA	< 1mA	< 3mA	
MECHANICAL					
Case Cover / Chassis	Aluminium				
Dimensions (L × W × D)	mm	121 × 32 × 125	121 × 50 × 123.1	121 × 85 × 124.1	121 × 144 × 118.6
	inch	4.76 × 1.26 × 4.92	4.76 × 1.97 × 4.85	4.76 × 3.35 × 4.86	4.76 × 5.67 × 4.67
Unit Weight	kg	0.38	0.72	0.96	1.37
	lb	0.84	1.59	2.12	3.02
Cooling System	Convection				
MTBF ³⁾	> 800,000 hrs	> 800,000 hrs	> 500,000 hrs	> 500,000 hrs	
ENVIRONMENT					
Operating Temperature ⁴⁾	-25°C to +80°C			-25°C to +75°C	
Storage Temperature	-40°C to +85°C				
Operating Humidity	5 to 95% RH (Non-Condensing)				
Operating Altitude	0 to 2,500 m (0 to 8,200 ft)				

Dimensions Reference

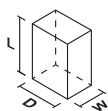

Notes

- 1) All models fulfill the test conditions for DC input. DC input safety approval can be obtained upon request.
- 2) At 25°C ambient temperature by vertical mounting orientation.
- 3) MTBF as per Telcordia SR-332 (Confidence level: 90%, I/P: 115Vac, O/P: 100% load) for vertical mounting orientation.
- 4) Refer power de-rating in the product datasheet.
- 5) All parameters are specified at 25°C ambient temperature unless otherwise indicated.



Features

- Universal AC input voltage range
- Built-in constant current circuit for charging application
- High efficiency of up to 94% at 230Vac
- Power Boost of 150% for 5s
- SEMI F47 compliance at 120Vac
- Extreme low temperature cold start at -40°C
- Built-in DC OK Contact and LED indicator for DC OK
- Conformal coating on PCBA to protect against common dust and chemical pollutants



Specifications

OUTPUT		DRP-24V120W1C□□N	DRP-24V240W1C□□N	DRP-24V480W1C□□N
Output Voltage		24V	24V	24V
Output Voltage Range		24-28V	24-28V	24-28V
Output Current		0-5.0A	0-10.0A	0-20.0A
Output Power		120W	240W	480W
PARD (20MHz)		< 100mVpp		
Hold-up Time	115Vac	> 20ms	> 20ms	> 15ms
	230Vac			
INPUT				
Phase Input	Single Phase			
Input Voltage Range	DRP-24V□□W1C□□N: 88-264Vac DRP-24V□□W1C□□N: 88-264Vac (DC input range 88-375Vdc) ¹⁾			
Input Frequency	47-63Hz			
Input Current	115Vac	< 1.4A	< 2.6A	< 5.0A
	230Vac	< 0.7A	< 1.3A	< 2.5A
Efficiency ²⁾ at 100% Load	115Vac	> 89.5%	> 91.0%	> 92.0%
	230Vac	> 91.0%	> 93.0%	> 93.0%
Max Inrush Current (Cold Start)	115Vac	< 35A	< 33A	< 40A
	230Vac	< 70A	< 65A	< 80A
Power Factor	115Vac	> 0.96	> 0.99	> 0.99
	230Vac	> 0.93	> 0.93	> 0.95
Leakage Current (264Vac, 50Hz)	TT/TN	< 0.47mA	< 0.74mA	< 1.12mA
	IT	< 1.20mA	< 2.00mA	< 2.55mA
MECHANICAL				
Case Cover / Chassis	Aluminium			
Dimensions (L × W × D)	mm	124 × 40 × 117	124 × 60 × 117	124 × 82 × 127
	inch	4.88 × 1.57 × 4.61	4.88 × 2.36 × 4.61	4.88 × 3.23 × 5.00
Unit Weight	kg	0.58	0.84	1.20
	lb	1.28	1.85	2.65
Cooling System	Convection			
MTBF ³⁾		> 1,411,300 hrs	> 1,366,200 hrs	> 1,041,600 hrs
ENVIRONMENT				
Operating Temperature ⁴⁾	-25°C to +70°C			
Storage Temperature	-40°C to +85°C			
Operating Humidity	5 to 95% RH (Non-Condensing)			
Operating Altitude	0 to 5,000 m (0 to 16,400 ft)			

Dimensions Reference

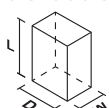

Notes

- 1) All models are certified for DC input.
- 2) At 25°C ambient temperature by vertical mounting orientation.
- 3) MTBF as per Telcordia SR-332 (Confidence level: 90%, I/P: 115Vac, O/P: 100% load) for vertical mounting orientation.
- 4) Refer power de-rating in the product datasheet.
- 5) All parameters are specified at 25°C ambient temperature unless otherwise indicated.



Features

- Universal AC input voltage range
- High power density in corrosion resistant aluminium casing
- Power Boost of 150% up to 7s
- Advanced Power Boost (APB)
- DNV GL and ABS approvals for maritime applications
- Extreme low temperature cold start at -40°C
- Built-in DC OK contact and LED indicator for DC OK/Over Load
- Conformal coating on PCBAs to protect against common dust and chemical pollutants



Specifications

OUTPUT		DRM-24V80W1PN	DRM-24V120W1PN	DRM-24V240W1PN	DRM-24V480W1PN	DRM-24V960W1PN
Output Voltage		24V	24V	24V	24V	24V
Output Voltage Range		24-28V	24-28V	24-28V	24-28V	24-28V
Output Current		3.4-3.0A	5.0-4.5A	10.0-9.0A	20.0-17.0A	40.0-34.3A
Output Power		81.6W	120W	240W	480W	960W
PARD (20MHz)		< 50mVpp			< 100mVpp	
Hold-up Time	120Vac	> 41ms	> 34ms	> 28ms	> 30ms	> 23ms
	230Vac	> 70ms	> 65ms			
INPUT						
Phase Input		Single Phase				
Input Voltage Range		85-276Vac (DC input range 88-375Vdc) ¹⁾	85-264Vac (DC input range 88-375Vdc) ¹⁾	85-276Vac (DC input range 88-375Vdc) ¹⁾		85-264Vac
Input Frequency		47-63Hz				
Input Current	120Vac	< 0.90A	< 1.12A	< 2.26A	< 4.60A	< 10.10A
	230Vac	< 0.60A	< 0.62A	< 1.25A	< 2.50A	< 6.00A
Efficiency ²⁾ at 100% Load	120Vac	> 90.1%	> 91.6%	> 92.6%	> 92.2%	> 93.6%
	230Vac	> 90.0%	> 92.7%	> 93.5%	> 93.4%	> 94.6%
Max Inrush Current (Cold Start)	120Vac	< 7A	< 15A	< 10A	< 13A	< 13A
	230Vac	< 13A				< 20A
Power Factor	120Vac	> 0.95	> 0.99	> 0.98	> 0.92	> 0.97
	230Vac	> 0.80	> 0.91	> 0.92	> 0.87	> 0.95
Leakage Current (264Vac, 50Hz)	TT/TN	< 0.36mA	< 0.45mA	< 0.74mA	< 0.80mA	< 1.18mA
	IT	< 0.95mA	< 1.08mA	< 1.29mA	< 2.00mA	< 2.82mA
MECHANICAL						
Case Cover / Chassis		Aluminium				
Dimensions (L × W × D)	mm	124 × 32 × 102	124 × 40 × 117	124 × 60 × 117	124 × 82 × 127	124 × 125 × 133.6
	inch	4.88 × 1.26 × 4.02	4.88 × 1.57 × 4.61	4.88 × 2.36 × 4.61	4.88 × 3.23 × 5.00	4.88 × 4.92 × 5.26
Unit Weight	kg	0.50	0.63	0.94	1.40	2.87
	lb	1.10	1.39	2.07	3.09	6.33
Cooling System		Convection				
MTBF ³⁾		> 2,000,000 hrs	> 1,800,000 hrs	> 1,400,000 hrs	> 778,800 hrs	> 513,800 hrs
ENVIRONMENT						
Operating Temperature ⁴⁾		-25°C to +70°C				
Storage Temperature		-40°C to +85°C				
Operating Humidity		5 to 95% RH (Non-Condensing)				
Operating Altitude		0 to 5,000 m (0 to 16,400 ft); IEC/EN 61558: 0 to 2,500 m (0 to 8,200 ft)				

Dimensions Reference

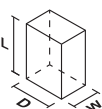

Notes

- 1) All models are certified for DC input. DC input is not applicable for DRM-24V960W1PN.
- 2) At 25°C ambient temperature by vertical mounting orientation.
- 3) MTBF as per Telcordia SR-332 (Confidence level: 90%, I/P: 100Vac, O/P: 100% load) for vertical mounting orientation.
- 4) Refer power de-rating in the product datasheet.
- 5) All parameters are specified at 25°C ambient temperature unless otherwise indicated.



Features

- SIL3 approval for SIS Functional Safety
- Droop method current sharing
- Active Redundant circuit O-Ring MOSFET
- Power Boost of 150% for 5s
- Advanced Power Boost (APB)
- Built-in DC OK Contact and LED indicator for DC OK/ Overload
- Conformal coating on PCBAs to protect against common dust and chemical pollutants

Specifications

		COMING SOON
OUTPUT		DRM-24V480W1SN
Output Voltage		24V
Output Voltage Range		24-28V
Output Current		20.0-17.0A
Output Power		480W
PARD (20MHz)		< 120mVpp
Hold-up Time	120Vac	> 30ms
	230Vac	
INPUT		
Phase Input		Single Phase
Input Voltage Range		85-276Vac (DC input range 88-375Vdc) ¹⁾
Input Frequency		47-63Hz
Input Current	120Vac	< 4.60A
	230Vac	< 2.50A
Efficiency ²⁾ at 100% Load	120Vac	> 92.2%
	230Vac	> 93.4%
Max Inrush Current (Cold Start)	120Vac	< 13A
	230Vac	
Power Factor	120Vac	> 0.92
	230Vac	> 0.87
Leakage Current (264Vac, 50Hz)	TT/TN	< 0.80mA
	IT	< 2.00mA
MECHANICAL		
Case Cover / Chassis		Aluminium
Dimensions (L x W x D)	mm	124 x 82 x 127
	inch	4.88 x 3.23 x 5.00
Unit Weight	kg	1.40
	lb	3.09
Cooling System		Convection
MTBF ³⁾		> 778,800 hrs
ENVIRONMENT		
Operating Temperature ⁴⁾		-25°C to +70°C
Storage Temperature		-40°C to +85°C
Operating Humidity		5 to 95% RH (Non-Condensing)
Operating Altitude		0 to 5,000 m (0 to 16,400 ft)

Dimensions Reference

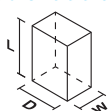

Notes

- 1) All models are certified for DC input.
- 2) At 25°C ambient temperature by vertical mounting orientation.
- 3) MTBF as per Telcordia SR-332 (Confidence level: 90%, I/P: 100Vac, O/P: 100% load) for vertical mounting orientation.
- 4) Refer power de-rating in the product datasheet.
- 5) All parameters are specified at 25°C ambient temperature unless otherwise indicated.



Features

- Built-in constant current circuit for charging application
- Full power from -25°C to +60°C @ 5,000m (16,400 ft.)
- Power Boost of 150% up to 7s
- Advanced Power Boost (APB)
- DNV GL and ABS approvals for maritime applications
- Built-in DC OK Contact and LED indicator for DC OK/Overload
- Conformal coating on PCBAs to protect against common dust and chemical pollutants

Specifications

		COMING SOON	COMING SOON
OUTPUT		DRM-24V480W3PN	DRM-24V960W3PN
Output Voltage		24V	24V
Output Voltage Range		24-28V	24-28V
Output Current		20.0-17.1A	40.0-34.3A
Output Power		480W	960W
PARD (20MHz)		< 100mVpp	< 100mVpp
Hold-up Time	3 × 400Vac	> 18ms	> 20ms
	3 × 500Vac		
INPUT			
Phase Input	Two or Three Phase		
Input Voltage Range	3 × 320-600Vac or 2 × 380-600Vac ¹⁾		
Input Frequency	47-63Hz		
Input Current	3 × 400Vac	< 0.79A	< 1.65A
	3 × 500Vac	< 0.68A	< 1.35A
Efficiency ²⁾ at 100% Load	3 × 400Vac	> 95.0%	> 95.3%
	3 × 500Vac	> 94.8%	> 95.2%
Max Inrush Current (Cold Start)	3 × 400Vac	< 10A	< 14.2
	3 × 500Vac		< 17.7
Power Factor	3 × 400Vac	> 0.93	> 0.90
	3 × 500Vac	> 0.90	
Leakage Current (3 × 500Vac, 60Hz)	TT/TN	< 2mA	< 2mA
	IT		
MECHANICAL			
Case Cover / Chassis	Aluminium		
Dimensions (L × W × D)	mm	124 × 65 × 127.1	124 × 110 × 128.6
	inch	4.88 × 2.56 × 5.00	4.88 × 4.33 × 5.06
Unit Weight	kg	1.18	2.30
	lb	2.60	5.07
Cooling System	Convection		
MTBF ³⁾	> 750,000 hrs		> 550,000 hrs
ENVIRONMENT			
Operating Temperature ⁴⁾	-25°C to +70°C		
Storage Temperature	-40°C to +85°C		
Operating Humidity	5 to 95% RH (Non-Condensing)		
Operating Altitude	0 to 5,000 m (0 to 16,400 ft)		

Dimensions Reference

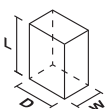

Notes

- 1) DRM-24V960W3PN fulfill the test conditions for this range. DC input safety approval can be obtained upon request. DC input is not applicable for DRM-24V480W3PN.
- 2) At 25°C ambient temperature by vertical mounting orientation.
- 3) MTBF as per Telcordia SR-332 (Confidence level: 90%, I/P: 3 × 400Vac, O/P: 100% load) for vertical mounting orientation.
- 4) Refer power de-rating in the product datasheet.
- 5) All parameters are specified at 25°C ambient temperature unless otherwise indicated.



Features

- Universal AC input voltage range
- LCD display monitoring the output current / voltage / peak current and temperature
- Life time expectancy alarm signal and monitoring
- Built-in active PFC with up to 94% efficiency
- Power Boost of 150% up to 7s
- Advanced Power Boost (APB)
- DC OK Contact and LED indicator for DC OK/ Overload
- Conformal coating on PCBAs to protect against common dust and chemical pollutants

Specifications

OUTPUT		DRV-24V120W1PN	DRV-24V240W1PN	DRV-24V480W1PN
Output Voltage		24V	24V	24V
Output Voltage Range		24-28V	24-28V	24-28V
Output Current		5.0-4.28A	10.0-8.57A	20.0-17.0A
Output Power		120W	240W	480W
PARD (20MHz)		< 50mVpp	< 50mVpp	< 100mVpp
Hold-up Time	120Vac	> 34ms	> 28ms	> 30ms
	230Vac	> 65ms		
INPUT				
Phase Input		Single Phase		
Input Voltage Range		85-264Vac (DC input range 88-375Vdc) ¹⁾	85-276Vac (DC input range 88-375Vdc) ¹⁾	
Input Frequency		47-63Hz		
Input Current	120Vac	< 1.13A	< 2.22A	< 4.60A
	230Vac	< 0.63A	< 1.21A	< 2.50A
Efficiency ²⁾ at 100% Load	120Vac	> 90.3%	> 92.6%	> 92.2%
	230Vac	> 91.2%	> 93.5%	> 93.4%
Max Inrush Current (Cold Start)	120Vac	< 15A	< 10A	< 13A
	230Vac			
Power Factor	120Vac	> 0.99	> 0.98	> 0.92
	230Vac	> 0.91	> 0.92	> 0.87
Leakage Current (264Vac, 50Hz)	TT/TN	< 0.45mA	< 0.74mA	< 0.80mA
	IT	< 1.08mA	< 2.10mA	< 2.00mA
MECHANICAL				
Case Cover / Chassis		Aluminium & Plastic / Aluminium		
Dimensions (L x W x D)	mm	124 x 60 x 139	124 x 60 x 139	124 x 82 x 149
	inch	4.88 x 2.36 x 5.47	4.88 x 2.36 x 5.47	4.88 x 3.23 x 5.87
Unit Weight	kg	0.75	1.02	1.45
	lb	1.65	2.25	3.20
Cooling System		Convection		
MTBF ³⁾		> 1,400,000 hrs	> 1,200,000 hrs	> 700,000 hrs
ENVIRONMENT				
Operating Temperature ⁴⁾		-25°C to +70°C		
Storage Temperature		-40°C to +85°C		
Operating Humidity		5 to 95% RH (Non-Condensing)		
Operating Altitude		0 to 5,000 m (0 to 16,400 ft)		

Dimensions Reference

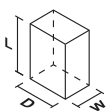

Notes

- 1) All models are certified for DC input.
- 2) At 25°C ambient temperature by vertical mounting orientation.
- 3) MTBF as per Telcordia SR-332 (Confidence level: 90%, I/P: 100Vac, O/P: 100% load) for vertical mounting orientation.
- 4) Refer power de-rating in the product datasheet.
- 5) All parameters are specified at 25°C ambient temperature unless otherwise indicated.

LYTE



Features

- Universal AC input voltage range
- High power density
- Built-in constant current circuit for reactive loads
- Conforms to harmonic current IEC/EN 61000-3-2, Class A
- Built-in DC OK relay contact (for DRL-□V□W1AS)
- Compliance to SEMI F47 @ 200Vac
- 15kV Air Discharge & 8kV Contact Discharge ESD immunity

Specifications

		COMING SOON		COMING SOON		
OUTPUT		DRL-12V75W1AZ	DRL-24V75W1AZ	DRL-24V120W1A□	DRL-24V240W1A□	DRL-24V480W1A□
Output Voltage		12V	24V	24V	24V	24V
Output Voltage Range		10.8-13.2V	21.6-26.4V	22-28V	22-28V	22-28V
Output Current		6.25A	3.125A	5.0A	10.0A	20.0A
Output Power		75W	75W	120W	240W	480W
PARD (20MHz)		< 80mVpp @ -10°C to +70°C	< 120mVpp @ -10°C to +70°C	< 120mVpp @ -10°C to +70°C, < 240mVpp @ -20°C to -10°C	< 120mVpp @ 0°C to +70°C, < 240mVpp @ -10°C to 0°C, < 360mVpp @ -20°C to -10°C	
Hold-up Time	115Vac	12ms typ.	12ms typ.	20ms typ.	10ms typ.	10ms typ.
	230Vac	60ms typ.	60ms typ.	90ms typ.	16ms typ.	16ms typ.
INPUT						
Phase Input		Single Phase				
Input Voltage Range		85-264Vac		85-264Vac (DC input range 120-375Vdc) ¹⁾		
Input Frequency		47-63Hz				
Input Current	115Vac	1.45A typ.	1.45A typ.	2.2A typ.	2.8A typ.	5.4A typ.
	230Vac	0.9A typ.	0.9A typ.	1.2A typ.	1.4A typ.	2.7A typ.
Efficiency ²⁾ at 100% Load	115Vac	-	-	85.0% typ.	88.0% typ.	85.0% typ.
	230Vac	85.5% typ.	88.5% typ.	88.0% typ.	90.0% typ.	88.0% typ.
Max Inrush Current (Cold Start)	115Vac	-	-	20A typ.	20A typ.	40A typ.
	230Vac	40A typ.	40A typ.	40A typ.	40A typ.	80A typ.
Power Factor	115Vac	NA	NA	Conform to EN 61000-3-2	> 0.95	> 0.95
	230Vac	-	-	-	-	-
Leakage Current	240Vac	< 1mA	< 1mA	-	-	-
	264Vac	-	-	< 0.25mA	< 1mA	< 1mA
MECHANICAL						
Case Cover / Chassis		Plastic			SGCC / Aluminium	
Dimensions (L × W × D)	mm	123.6 × 27 × 102	123.6 × 27 × 102	123.6 × 40 × 117.6	123.6 × 60 × 117.6	123.6 × 85.5 × 128.5
	inch	4.87 × 1.06 × 4.02	4.87 × 1.06 × 4.02	4.87 × 1.57 × 4.63	4.87 × 2.36 × 4.63	4.87 × 3.37 × 5.06
Unit Weight	kg	TBA	TBA	0.54	0.80	1.30
	lb	TBA	TBA	1.19	1.76	2.86
Cooling System		Convection				
MTBF ³⁾		> 700,000 hrs	> 700,000 hrs	> 700,000 hrs	> 700,000 hrs	> 700,000 hrs
ENVIRONMENT						
Operating Temperature ⁴⁾		-20°C to +70°C				
Storage Temperature		-40°C to +85°C				
Operating Humidity		5 to 95% RH (Non-Condensing)				
Operating Altitude		Industrial Application: 0 to 2,000 m (0 to 6,560 ft) ITE Application: 0 to 5,000 m (0 to 16,400 ft)				

Dimensions Reference

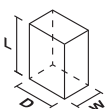

Notes

- 1) All models fulfill the test conditions for DC input except DRL-12V75W1AZ and DRL-24V75W1AZ. DC input safety approval can be obtained upon request.
- 2) At 25°C ambient temperature by vertical mounting orientation.
- 3) MTBF as per Telcordia SR-332 (Confidence level: 90%, I/P: 100Vac, O/P: 100% load) for vertical mounting orientation.
- 4) Refer power de-rating in the product datasheet.
- 5) All parameters are specified at 25°C ambient temperature unless otherwise indicated.

LYTE



Features

- Universal AC input voltage range
- High power density
- Built-in constant current circuit for reactive loads
- Conforms to harmonic current IEC/EN 61000-3-2, Class A
- Built-in DC OK relay contact (for DRL-□V□W1AS)
- Compliance to SEMI F47 @ 200Vac
- 15kV Air Discharge & 8kV Contact Discharge ESD immunity

Specifications

COMING SOON		
OUTPUT	DRL-48V75W1AZ	DRL-48V120W1A□
Output Voltage	48V	48V
Output Voltage Range	43.2-52.8V	44-56V
Output Current	1.57A	2.50A
Output Power	75.36W	120W
PARD (20MHz)	< 150mVpp @ -10°C to +70°C	< 150mVpp @ -10°C to +70°C, < 300mVpp @ -20°C to -10°C
Hold-up Time	115Vac	12ms typ.
	230Vac	60ms typ.
INPUT		
Phase Input	Single Phase	
Input Voltage Range	85-264Vac	85-264Vac (DC input range 120-375Vdc) ¹⁾
Input Frequency	47-63Hz	
Input Current	115Vac	1.45A typ.
	230Vac	0.9A typ.
Efficiency ²⁾ at 100% Load	115Vac	-
	230Vac	88.5% typ.
Max Inrush Current (Cold Start)	115Vac	-
	230Vac	40A typ.
Power Factor	115Vac	NA
	230Vac	NA
Leakage Current	240Vac	< 1mA
	264Vac	-
MECHANICAL		
Case Cover / Chassis	Plastic	SGCC / Aluminium
Dimensions (L × W × D)	mm	123.6 × 27 × 102
	inch	4.87 × 1.06 × 4.02
Unit Weight	kg	TBA
	lb	TBA
Cooling System	Convection	
MTBF ³⁾	> 700,000 hrs	> 700,000 hrs
ENVIRONMENT		
Operating Temperature ⁴⁾	-20°C to +70°C	
Storage Temperature	-40°C to +85°C	
Operating Humidity	5 to 95% RH (Non-Condensing)	
Operating Altitude	Industrial Application: 0 to 2,000 m (0 to 6,560 ft) ITE Application: 0 to 5,000 m (0 to 16,400 ft)	

Dimensions Reference

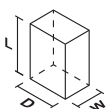

Notes

- 1) DRL-48V120W1A□ models fulfill the test conditions for DC input. DC input safety approval can be obtained upon request.
- 2) At 25°C ambient temperature by vertical mounting orientation.
- 3) MTBF as per Telcordia SR-332 (Confidence level: 90%, I/P: 100Vac, O/P: 100% load) for vertical mounting orientation.
- 4) Refer power de-rating in the product datasheet.
- 5) All parameters are specified at 25°C ambient temperature unless otherwise indicated.

CHROME

Features



- Class II Double Isolation (No earth connection is required)
- Universal AC input voltage range and full power up to 55°C
- Power will not de-rate for the entire input voltage range
- Can be installed in compact cabinets
- NEC Class 2 and Limited Power Source (LPS) approvals (except DRC-12V100W1AZ)
- Conforms to harmonic current IEC/EN 61000-3-2, Class A
- Safety approval according to IEC/EN/UL 60950-1 (ITE standard) and UL 508 (Industrial standard)

Specifications

OUTPUT		DRC-5V10W1A□	DRC-12V10W1A□	DRC-12V30W1A□	DRC-12V60W1□□	DRC-12V100W1AZ
Output Voltage		5V	12V	12V	12V	12V
Output Voltage Range		5V (No potentiometer)	12V (No potentiometer)	11.5-14.5V	11.5-14.0V	12-14V
Output Current		0-1.5A	0-0.83A	0-2.1A	0-4.5A	0-6.0A
Output Power		7.5W	10W	25.2W	54W	72W
PARD (20MHz)		< 150mVpp				< 100mVpp
Hold-up Time	115Vac	> 10ms	> 10ms	> 25ms	> 16ms	> 20ms
	230Vac	> 30ms	> 30ms	> 30ms	> 30ms	> 100ms
INPUT						
Phase Input		Single Phase				
Input Voltage Range		90-264Vac			90-264Vac (DC input range 125-375Vdc) ¹⁾	90-264Vac
Input Frequency		47-63Hz				
Input Current	115Vac	< 0.3A	< 0.3A	< 0.8A	< 1.5A	< 1.5A
	230Vac	< 0.2A	< 0.2A	< 0.6A	< 0.8A	< 0.9A
Efficiency ²⁾ at 100% Load	115Vac	> 78.0%	> 82.0%	> 85.0%	> 86.0%	> 86.0%
	230Vac	> 77.0%				
Max Inrush Current (Cold Start)	115Vac	< 15A	< 15A	< 25A	< 30A	< 30A
	230Vac	< 30A	< 30A	< 50A	< 60A	< 65A
Power Factor		Conform to EN 61000-3-2				
Leakage Current	240Vac	< 0.25mA	< 0.25mA	< 0.25mA	< 0.25mA	-
	264Vac	-	-	-	-	< 0.25mA
MECHANICAL						
Case Cover / Chassis		Plastic				
Dimensions (L × W × D)	mm	91 × 18 × 55.6	91 × 18 × 55.6	91 × 53 × 55.6	91 × 71 × 55.6	91 × 89.9 × 55.6
	inch	3.58 × 0.71 × 2.19	3.58 × 0.71 × 2.19	3.58 × 2.09 × 2.19	3.58 × 2.80 × 2.19	3.58 × 3.54 × 2.19
Unit Weight	kg	0.06	0.06	0.14	0.22	0.36
	lb	0.13	0.13	0.31	0.49	0.79
Cooling System		Convection				
MTBF ³⁾		> 500,000 hrs	> 500,000 hrs	> 500,000 hrs	> 500,000 hrs	> 500,000 hrs
ENVIRONMENT						
Operating Temperature ⁴⁾		-25°C to +71°C				
Storage Temperature		-25°C to +85°C				-40°C to +85°C
Operating Humidity		5 to 95% RH (Non-Condensing)				
Operating Altitude		0 to 2,000 m (0 to 6,560 ft)				

Dimensions Reference

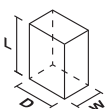

Notes

- 1) DRC-12V60W1CZ is certified for DC input.
- 2) At 25°C ambient temperature by vertical mounting orientation.
- 3) MTBF as per Telcordia SR-332 (Confidence level: 90%, I/P: 100Vac, O/P: 100% load, Ta: 35°C) for vertical mounting orientation.
- 4) Refer power de-rating in the product datasheet.
- 5) All parameters are specified at 25°C ambient temperature unless otherwise indicated.

CHROME



Features

- Class II Double Isolation (No earth connection is required)
- Universal AC input voltage range and full power up to 55°C
- Power will not de-rate for the entire input voltage range
- Can be installed in compact cabinets
- NEC Class 2 and Limited Power Source (LPS) approvals
- Conforms to harmonic current IEC/EN 61000-3-2, Class A
- Safety approval according to IEC/EN/UL 60950-1 (ITE standard) and UL 508 (Industrial standard)
- Household appliance approvals IEC/EN 60335-1 (DRC-24V10W1HZ)

Specifications

OUTPUT		DRC-24V10W1A□	DRC-24V10W1HZ	DRC-24V30W1A□	DRC-24V60W1A□	DRC-24V100W1A□
Output Voltage		24V	24V	24V	24V	24V
Output Voltage Range		24V (No potentiometer)	24V (No potentiometer)	23.52-24.48V	24-28V	22-24V
Output Current		0-0.42A	0-0.42A	0-1.25A	0-2.5A	0-3.8A
Output Power		10W	10W	30W	60W	91.2W
PARD (20MHz)		< 150mVpp				
Hold-up Time	115Vac	> 10ms	> 10ms	> 25ms	> 16ms	> 10ms
	230Vac	> 30ms	> 30ms	> 30ms	> 30ms	> 30ms
INPUT						
Phase Input		Single Phase				
Input Voltage Range		90-264Vac				90-264Vac (DC input range 125-375Vdc)
Input Frequency		47-63Hz				
Input Current	115Vac	< 0.3A	< 0.3A	< 0.8A	< 1.5A	< 2.2A
	230Vac	< 0.2A	< 0.2A	< 0.6A	< 1.0A	< 1.0A
Efficiency ¹⁾ at 100% Load	115Vac	> 80.0%	> 80.0%	> 83.0%	> 86.0%	> 85.0%
	230Vac	> 80.0%	> 80.0%	> 83.0%	> 86.0%	> 87.0%
Max Inrush Current (Cold Start)	115Vac	< 15A	< 15A	< 25A	< 30A	< 30A
	230Vac	< 30A	< 30A	< 50A	< 60A	< 60A
Power Factor		Conform to EN 61000-3-2				
Leakage Current	240Vac	< 0.25mA	< 0.25mA	< 0.25mA	< 0.25mA	< 0.25mA
MECHANICAL						
Case Cover / Chassis		Plastic				
Dimensions (L × W × D)	mm	91 × 18 × 55.6	91 × 18 × 55.6	91 × 53 × 55.6	91 × 71 × 55.6	91 × 89.9 × 55.6
	inch	3.58 × 0.71 × 2.19	3.58 × 0.71 × 2.19	3.58 × 2.09 × 2.19	3.58 × 2.80 × 2.19	3.58 × 3.54 × 2.19
Unit Weight	kg	0.065	0.065	0.14	0.22	0.35
	lb	0.14	0.14	0.31	0.49	0.77
Cooling System		Convection				
MTBF ²⁾		> 500,000 hrs	> 500,000 hrs	> 500,000 hrs	> 500,000 hrs	> 500,000 hrs
ENVIRONMENT						
Operating Temperature ³⁾		-25°C to +71°C				
Storage Temperature		-25°C to +85°C				
Operating Humidity		5 to 95% RH (Non-Condensing)				
Operating Altitude		0 to 2,000 m (0 to 6,560 ft)				

Dimensions Reference

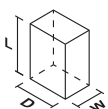

Notes

- 1) At 25°C ambient temperature by vertical mounting orientation.
- 2) MTBF as per Telcordia SR-332 (Confidence level: 90%, I/P: 100Vac, O/P: 100% load, Ta: 35°C) for vertical mounting orientation.
- 3) Refer power de-rating in the product datasheet.
- 4) All parameters are specified at 25°C ambient temperature unless otherwise indicated.

sync



Features

- Ultra-compact size and galvanic isolation up to 3.0kVdc between input to output and input to ground
- Universal AC input voltage range and full power from -10°C to +55°C operation
- Up to 89.0% efficiency
- Low earth leakage current < 0.5mA @ 264Vac
- Built-in DC OK relay contact option available
- Extreme low temperature cold start at -40°C
- NEC Class 2 / Limited Power Source (LPS) certified

Specifications

OUTPUT	DRS-5V30W1NZ	DRS-5V50W1A□	DRS-5V50W1N□	DRS-12V50W1N□
Output Voltage	5V	5V	5V	12V
Output Voltage Range	5-5.5V	5-5.5V	5-5.5V	12-15V
Output Current	0-3.0A	0-6.0A	0-5.0A	0-4.0A
Output Power	15W	30W	25W	48W
PARD (20MHz)	< 75mVpp @ > 0°C to 70°C, < 150mVpp @ 0°C to -20°C		< 50mVpp @ > 0°C to 70°C, < 150mVpp @ 0°C to -20°C	< 50mVpp @ > 0°C to 70°C, < 100mVpp @ 0°C to -20°C
Hold-up Time	115Vac > 20ms	> 20ms	> 20ms	> 20ms
	230Vac > 100ms	> 100ms	> 100ms	> 100ms
INPUT				
Phase Input	Single Phase			
Input Voltage Range	85-264Vac (DC input range 120-375Vdc) ¹⁾			
Input Frequency	47-63Hz			
Input Current	115Vac < 0.40A	< 0.60A	< 0.60A	< 0.90A
	230Vac < 0.20A	< 0.40A	< 0.40A	< 0.55A
Efficiency ²⁾ at 100% Load	115Vac > 79.0%	> 82.0%	> 82.0%	> 88.0%
	230Vac > 79.0%	> 82.0%	> 82.0%	> 89.0%
Max Inrush Current (Cold Start)	115Vac < 20A	< 35A	< 35A	< 25A
	230Vac < 40A	< 65A	< 60A	< 50A
Power Factor	Conform to EN 61000-3-2			
Leakage Current	264Vac < 0.5mA	< 0.75mA	< 0.75mA	< 0.5mA
MECHANICAL				
Case Cover / Chassis	Plastic			
Dimensions (L × W × D)	mm	75 × 21 × 89.5	75 × 30 × 89.5	75 × 30 × 89.5
	inch	2.95 × 0.83 × 3.52	2.95 × 1.18 × 3.52	2.95 × 1.18 × 3.52
Unit Weight	kg	0.11	0.16	0.18
	lb	0.24	0.35	0.40
Cooling System	Convection			
MTBF ³⁾	> 700,000 hrs	> 700,000 hrs	> 700,000 hrs	> 700,000 hrs
ENVIRONMENT				
Operating Temperature ⁴⁾	-20°C to +70°C			
Storage Temperature	-40°C to +85°C			
Operating Humidity	5 to 95% RH (Non-Condensing)			
Operating Altitude	0 to 2,000 m (0 to 6,560 ft)			

Dimensions Reference

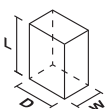

Notes

- 1) All models fulfill the test conditions for DC input. DC input safety approval can be obtained upon request.
- 2) At 25°C ambient temperature by vertical mounting orientation.
- 3) MTBF as per Telcordia SR-332 (Confidence level: 90%, I/P: 115Vac & 230Vac, O/P: 100% load) for vertical mounting orientation.
- 4) Refer power de-rating in the product datasheet.
- 5) All parameters are specified at 25°C ambient temperature unless otherwise indicated.



Features

- Ultra-compact size and galvanic isolation up to 3.0kVdc between input to output and input to ground
- Universal AC input voltage range and full power from -10°C to +55°C operation
- Up to 90.0% efficiency
- Low earth leakage current < 0.5mA @ 264Vac
- Built-in DC OK relay contact option available
- Extreme low temperature cold start at -40°C
- NEC Class 2 / Limited Power Source (LPS) certified

Specifications

OUTPUT		DRS-24V30W1AZ	DRS-24V30W1NZ	DRS-24V50W1N□	DRS-24V100W1A□	DRS-24V100W1N□	
Output Voltage		24V	24V	24V	24V	24V	
Output Voltage Range		21.6-26.4V	24-28V	24-28V	24-28V	22-24V	
Output Current		0-1.25A	0-1.25A	0-2.1A	0-4.0A	0-3.8A	
Output Power		30W	30W	50W	96W	91.2W	
PARD (20MHz)		< 150mVpp	< 75mVpp @ > 0°C to 70°C, < 150mVpp @ 0°C to -20°C	< 70mVpp @ > 0°C to 70°C, < 100mVpp @ 0°C to -20°C	< 50mVpp @ > 0°C to 70°C, < 100mVpp @ 0°C to -20°C		
Hold-up Time	115Vac	-	> 20ms	> 20ms	> 50ms	> 50ms	
	230Vac	> 20ms	> 100ms	> 100ms			
INPUT							
Phase Input		Single Phase					
Input Voltage Range		85-264Vac	85-264Vac (DC input range 120-375Vdc) ¹⁾				
Input Frequency		47-63Hz					
Input Current	115Vac	< 0.80A	< 0.55A	< 0.95A	< 1.20A	< 1.20A	
	230Vac	< 0.40A	< 0.35A	< 0.55A	< 0.60A	< 0.60A	
Efficiency ²⁾ at 100% Load	115Vac	-	> 87.5%	> 89.0%	> 89.0%	> 89.0%	
	230Vac	88.0% typ.	> 88.0%	> 90.0%			
Max Inrush Current (Cold Start)	115Vac	-	< 20A	< 30A	< 25A	< 25A	
	230Vac	< 60A	< 40A	< 50A	< 40A	< 40A	
Power Factor	115Vac	Conform to EN 61000-3-2				> 0.97	> 0.97
	230Vac				> 0.90	> 0.90	
Leakage Current	240Vac	< 0.5mA	-	-	-	-	
	264Vac	-	< 0.5mA	< 0.5mA	< 0.5mA	< 0.5mA	
MECHANICAL							
Case Cover / Chassis		Plastic					
Dimensions (L × W × D)	mm	75 × 21 × 89.5	75 × 21 × 89.5	75 × 30 × 89.5	75 × 45 × 100	75 × 45 × 100	
	inch	2.95 × 0.83 × 3.52	2.95 × 0.83 × 3.52	2.95 × 1.18 × 3.52	2.95 × 1.77 × 3.94	2.95 × 1.77 × 3.94	
Unit Weight	kg	0.10	0.11	0.18	0.325	0.325	
	lb	0.22	0.24	0.40	0.72	0.72	
Cooling System		Convection					
MTBF ³⁾		> 700,000 hrs	> 700,000 hrs	> 700,000 hrs	> 700,000 hrs	> 700,000 hrs	
ENVIRONMENT							
Operating Temperature ⁴⁾		-20°C to +70°C					
Storage Temperature		-40°C to +85°C					
Operating Humidity		5 to 95% RH (Non-Condensing)					
Operating Altitude		0 to 2,000 m (0 to 6,560 ft)					

Dimensions Reference

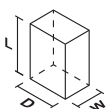

Notes

- 1) All models fulfill the test conditions for DC input. DC input safety approval can be obtained upon request.
- 2) At 25°C ambient temperature by vertical mounting orientation.
- 3) MTBF as per Telcordia SR-332 (Confidence level: 90%, I/P: 115Vac & 230Vac, O/P: 100% load) for vertical mounting orientation.
- 4) Refer power de-rating in the product datasheet.
- 5) All parameters are specified at 25°C ambient temperature unless otherwise indicated.

INDUSTRIAL POWER SUPPLIES

| Panel Mount Power Supply



AR

PMT

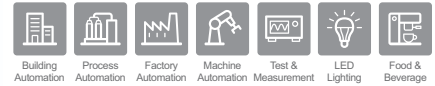

- AC input voltage selectable by switch (Universal AC input voltage range for selected models only)
- Conforms to harmonic current IEC/EN 61000-3-2, Class A (except 200W and 350W)
- Versatile configuration options: Open Frame, L Frame, Enclosed



AR

PMT2

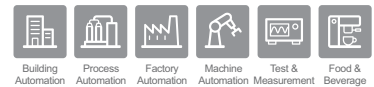

- Household appliance approvals to IEC/EN 60335-1, IEC/EN 61558-1 and IEC/EN 61558-2-16 (only 35W-150W)
- No load power consumption
- Low profile design: 30mm height
- Over Voltage Category III (only 35W-150W)
- Cold start at -40°C



AR

PMC



- Power will not de-rate for the entire input voltage range (except 600W)
- Full corrosion resistant aluminium casing (except 15W and 600W)
- Safety approval according to IEC/EN/UL 60950-1 (ITE standard) and EMI to EN 55032, Class B
- Also available: IP20 and Front Face connectors for selected models



AR

PMH



- Household appliance approvals to IEC/EN 60335-1, IEC/EN 61558-1 and IEC/EN 61558-2-16
- Full corrosion resistant aluminium casing
- Low profile design for 1U installation (for PMH-12V100WCL□, PMH-12V100WCM□, PMH-24V100WCL□, PMH-24V100WCM□ and PMH-24V150WCL□)
- NEC Class 2 options available



AR

PMF

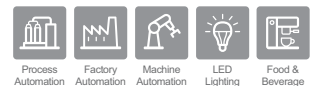

- Built-in active PFC and automatic fan speed control
- Full corrosion resistant aluminium casing
- Remote ON/OFF is available as an option
- Short Circuit / Overvoltage / Overcurrent / Over Temperature Protections



AR

PMR



- Full corrosion resistant aluminium casing
- Built-in active PFC and conforms to harmonic current IEC/EN 61000-3-2, Class A and Class D
- Low profile design for 1U installation
- Built-in DC OK relay contact and redundancy operation (PMR-□V320WDBA and PMR-□V320WDCA)



AR

PMU

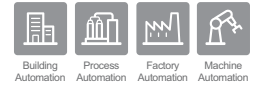

- AC input voltage selectable by switch
- LED indicators for DC OK (Green) and Battery Reverse Polarity Connection (Red)
- Zero switch over time from loss of AC to battery operation
- Monitoring signals for AC OK, DC OK and Battery Low indication



AR

MEB



- 2 × MOPP isolation, Suitable for type BF medical products
- Compliant with IEC 60601-1-2 Ed. 4 requirements
- PMBus Ver 1.3 supported
- Intelligent fan speed control
- Safety approvals for medical and IT applications

PAGES 92-93

Connector Options



Terminal Block connector



IP20 connector



Front Face connector



Harness connector



PMT

Features

- AC input voltage range selectable by switch (Universal AC input voltage range for selected models)
- Conforms to harmonic current IEC/EN 61000-3-2, Class A for selected models
- High MTBF > 700,000 hrs per Telcordia SR-332
- Short Circuit / Overvoltage / Overload / Over Temperature Protections
- Versatile configuration options (for 35W and 50W):
 - L Frame
 - Enclosed

Specifications

OUTPUT		PMT-4V350W1A□	PM□-5V35W1A□	PM□-5V50W1A□	PMT-5V350W1A□
Output Voltage		4.2V	5V	5V	5V
Output Voltage Range		3.78-4.70V	4.50-5.50V	4.50-5.50V	4.50-5.50V
Output Current		60.0A	7.0A	10.0A	60.0A
Output Power		252W	35W	50W	300W
PAR (20MHz)		< 150mVpp	< 80mVpp		< 150mVpp
Hold-up Time	115Vac	16ms typ.	20ms typ.	20ms typ.	16ms typ.
	230Vac	20ms typ.	100ms typ.	100ms typ.	20ms typ.
INPUT					
Phase Input		Single Phase			
Input Voltage Range		90-132Vac, 180-264Vac (Selectable by Switch)	85-264Vac		90-132Vac, 180-264Vac (Selectable by Switch)
Input Frequency		47-63Hz			
Input Current	115Vac	7.00A typ.	0.75A typ.	1.10A typ.	7.00A typ.
	230Vac	4.00A typ.	0.50A typ.	0.65A typ.	4.00A typ.
Efficiency ¹⁾ at 100% Load	230Vac	76.0% typ.	81.0% typ.	82.0% typ.	78.0% typ.
Max Inrush Current (Cold Start)	115Vac	40A typ.	-	-	40A typ.
	230Vac	60A typ.	45A typ.	45A typ.	60A typ.
Power Factor		NA	Conform to EN 61000-3-2		NA
Leakage Current	240Vac	< 1mA	< 0.5mA	< 1mA	< 1mA
MECHANICAL					
Case Cover / Chassis		Aluminium	SGCC / Aluminium		Aluminium
Dimensions (L × W × H)	mm	215 × 115 × 50	98 × 98 × 38	98 × 98 × 38	215 × 115 × 50
	inch	8.46 × 4.53 × 1.97	3.86 × 3.86 × 1.50	3.86 × 3.86 × 1.50	8.46 × 4.53 × 1.97
Unit Weight	kg	0.81	0.23	0.23	0.81
	lb	1.79	0.51	0.51	1.79
Cooling System		Forced Air (Built-in Fan)	Convection		Forced Air (Built-in Fan)
MTBF ²⁾		> 700,000 hrs	> 700,000 hrs	> 700,000 hrs	> 700,000 hrs
ENVIRONMENT					
Operating Temperature ³⁾		-10°C to +70°C			
Storage Temperature		-25°C to +85°C			
Operating Humidity		5 to 95% RH (Non-Condensing)			
Operating Altitude		0 to 5,000 m (0 to 16,400 ft)			

Dimensions Reference

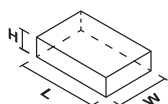

Notes

- 1) At 25°C ambient temperature by vertical mounting orientation.
- 2) MTBF as per Telcordia SR-332 (Confidence level: 90%, I/P: 100Vac, O/P: 100% load, Ta: 35°C). For PMT-4V350W1A□ and PMT-5V350W1A□ models, MTBF calculations do not include fan life time.
- 3) Refer power de-rating in the product datasheet.
- 4) All parameters are specified at 25°C ambient temperature unless otherwise indicated.



PMT

Features

- AC input voltage range selectable by switch (Universal AC input voltage range for selected models)
- Conforms to harmonic current IEC/EN 61000-3-2, Class A
- High MTBF > 700,000 hrs per Telcordia SR-332
- Short Circuit / Overvoltage / Overload / Over Temperature Protections
- Versatile configuration options (for 150W and below):
 - Open Frame (35W and 50W)
 - L Frame
 - Enclosed

Specifications

OUTPUT		PMT-12V35W1A□	PMT-12V50W1A□	PMT-12V100W1A□	PMT-12V150W1A□	PMT-12V350W1A□
Output Voltage		12V	12V	12V	12V	12V
Output Voltage Range		11-14V	11-14V	11.4-13.2V	11.4-13.5V	10.8-13.2V
Output Current		2.92A	4.17A	8.5A	12.5A	29.0A
Output Power		35W	50W	102W	150W	348W
PARD (20MHz)		< 100mVpp		< 120mVpp		< 150mVpp
Hold-up Time	115Vac	16.7ms typ.	16.7ms typ.	25ms typ.	20ms typ.	12ms typ.
	230Vac	-	-	30ms typ.	24ms typ.	16ms typ.
INPUT						
Phase Input	Single Phase					
Input Voltage Range	90-264Vac			90-132Vac, 180-264Vac (Selectable by Switch)		
Input Frequency	47-63Hz					
Input Current	115Vac	0.75A typ.	1.10A typ.	2.00A typ.	3.00A typ.	7.00A typ.
	230Vac	0.50A typ.	0.70A typ.	1.20A typ.	2.00A typ.	4.00A typ.
Efficiency ¹⁾ at 100% Load	115Vac					
	230Vac	84.0% typ.	83.0% typ.	87.5% typ.	86.0% typ.	84.0% typ.
Max Inrush Current (Cold Start)	115Vac	30A typ.	30A typ.			50A typ.
	230Vac	60A typ.	65A typ.	36A typ.	45A typ.	60A typ.
Power Factor	Conform to EN 61000-3-2					
Leakage Current	240Vac	< 1mA	< 1mA	< 0.5mA	< 0.5mA	< 3.5mA
MECHANICAL						
Case Cover / Chassis	SGCC / Aluminium					
Dimensions (L × W × H)	mm	98 × 98 × 38	98 × 98 × 38	158 × 97 × 38	178 × 97 × 38	215 × 115 × 50
	inch	3.86 × 3.86 × 1.50	3.86 × 3.86 × 1.50	6.22 × 3.82 × 1.50	7.01 × 3.82 × 1.50	8.46 × 4.53 × 1.97
Unit Weight	kg	0.22	0.23	0.36	0.48	0.82
	lb	0.49	0.51	0.79	1.06	1.81
Cooling System	Convection					Forced Air (Built-in Fan)
MTBF ²⁾		> 700,000 hrs	> 700,000 hrs	> 700,000 hrs	> 700,000 hrs	> 700,000 hrs
ENVIRONMENT						
Operating Temperature ³⁾	-10°C to +70°C					
Storage Temperature	-25°C to +85°C					
Operating Humidity	5 to 95% RH (Non-Condensing)					
Operating Altitude	0 to 5,000 m (0 to 16,400 ft)					

Dimensions Reference

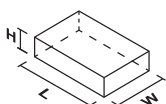

Notes

- 1) At 25°C ambient temperature by vertical mounting orientation.
- 2) MTBF as per Telcordia SR-332 (Confidence level: 90%, I/P: 100Vac, O/P: 100% load, Ta: 35°C). For PMT-12V350W1A□ models, MTBF calculations do not include fan life time.
- 3) Refer power de-rating in the product datasheet.
- 4) All parameters are specified at 25°C ambient temperature unless otherwise indicated.



PMT

Features

- AC input voltage range selectable by switch (Universal AC input voltage range for selected models)
- Conforms to harmonic current IEC/EN 61000-3-2, Class A
- High MTBF > 700,000 hrs per Telcordia SR-332
- Short Circuit / Overvoltage / Overload / Over Temperature Protections
- Versatile configuration options (for 35W and 50W):
 - Open Frame (35W and 50W, except 15V 50W)
 - L Frame
 - Enclosed

Specifications

OUTPUT		PM□-15V50W1A□	PM□-24V35W1A□	PM□-24V50W1A□	PM□-24V100W1A□	PM□-24V150W1A□
Output Voltage		15V	24V	24V	24V	24V
Output Voltage Range		13.5-16.5V	22-28V	22-28V	22.8-26.4V	22.8-27.6V
Output Current		3.4A	1.46A	2.1A	4.5A	6.5A
Output Power		51W	35W	50W	108W	156W
PARD (20MHz)		< 150mVpp	< 100mVpp		< 120mVpp	
Hold-up Time	115Vac	20ms typ.	16.7ms typ.	16.7ms typ.	25ms typ.	20ms typ.
	230Vac	100ms typ.	-	-	30ms typ.	24ms typ.
INPUT						
Phase Input		Single Phase				
Input Voltage Range		85-264Vac	90-264Vac		90-132Vac, 180-264Vac (Selectable by Switch)	
Input Frequency		47-63Hz				
Input Current	115Vac	1.10A typ.	0.75A typ.	1.10A typ.	2.00A typ.	3.00A typ.
	230Vac	0.65A typ.	0.50A typ.	0.65A typ.	1.20A typ.	2.00A typ.
Efficiency ¹⁾ at 100% Load	115Vac	-	85.0% typ.	86.0% typ.	-	-
	230Vac	85.5% typ.			89.0% typ.	89.0% typ.
Max Inrush Current (Cold Start)	115Vac	-	30A typ.	30A typ.	-	-
	230Vac	45A typ.	60A typ.	60A typ.	36A typ.	45A typ.
Power Factor		Conform to EN 61000-3-2				
Leakage Current	240Vac	< 0.5mA	< 1mA	< 1mA	< 0.5mA	< 0.5mA
MECHANICAL						
Case Cover / Chassis		SGCC / Aluminium				
Dimensions (L × W × H)	mm	98 × 98 × 38	98 × 98 × 38	98 × 98 × 38	158 × 97 × 38	178 × 97 × 38
	inch	3.86 × 3.86 × 1.50	3.86 × 3.86 × 1.50	3.86 × 3.86 × 1.50	6.22 × 3.82 × 1.50	7.01 × 3.82 × 1.50
Unit Weight	kg	0.23	0.22	0.24	0.36	0.48
	lb	0.51	0.49	0.53	0.79	1.06
Cooling System		Convection				
MTBF ²⁾		> 700,000 hrs	> 700,000 hrs	> 700,000 hrs	> 700,000 hrs	> 700,000 hrs
ENVIRONMENT						
Operating Temperature ³⁾		-10°C to +70°C				
Storage Temperature		-25°C to +85°C				
Operating Humidity		5 to 95% RH (Non-Condensing)				
Operating Altitude		0 to 5,000 m (0 to 16,400 ft)				

Dimensions Reference

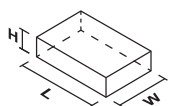

Notes

- 1) At 25°C ambient temperature by vertical mounting orientation.
- 2) MTBF as per Telcordia SR-332 (Confidence level: 90%, I/P: 100Vac, O/P: 100% load, Ta: 35°C).
- 3) Refer power de-rating in the product datasheet.
- 4) All parameters are specified at 25°C ambient temperature unless otherwise indicated.



PMT

Features

- AC input voltage range selectable by switch
- Full corrosion resistant aluminium casing
- High Efficiency > 87.0% @ 230Vac
- High MTBF > 700,000 hrs per Telcordia SR-332
- Short Circuit / Overvoltage / Overload / Over Temperature Protections
- Versatile configuration options (for 200W):
 - L Frame
 - Enclosed

Specifications

OUTPUT		PMT-24V200W1A□	PMT-24V350W1AG	PMT-24V350W1AM	PMT-24V350W1AK	PMT-24V350W1AR
Output Voltage		24V	24V	24V	24V	24V
Output Voltage Range		21.6-26.4V	20.0-26.4V	20.0-26.4V	20.0-26.4V	20.0-26.4V
Output Current		8.8A	14.6A	14.6A	14.6A	14.6A
Output Power		211.2W	350.4W	350.4W	350.4W	350.4W
PARD (20MHz)		< 150mVpp				
Hold-up Time	115Vac	20ms typ.	16ms typ.	16ms typ.	16ms typ.	16ms typ.
	230Vac	24ms typ.	20ms typ.	20ms typ.	20ms typ.	20ms typ.
INPUT						
Phase Input		Single Phase				
Input Voltage Range		90-132Vac, 180-264Vac (Selectable by Switch)				
Input Frequency		47-63Hz				
Input Current	115Vac	4.5A typ.	7.0A typ.	7.0A typ.	7.0A typ.	7.0A typ.
	230Vac	2.5A typ.	4.0A typ.	4.0A typ.	4.0A typ.	4.0A typ.
Efficiency ¹⁾ at 100% Load	230Vac	88.5% typ.	87.0% typ.	87.0% typ.	87.0% typ.	87.0% typ.
Max Inrush Current (Cold Start)	115Vac	-	50A typ.	50A typ.	50A typ.	50A typ.
	230Vac	55A typ.	60A typ.	60A typ.	60A typ.	60A typ.
Power Factor		NA				
Leakage Current	240Vac	< 0.25mA	< 3.5mA	< 3.5mA	< 3.5mA	< 3.5mA
MECHANICAL						
Case Cover / Chassis		Aluminium				
Dimensions (L × W × H)	mm	215 × 115 × 50	215 × 115 × 50	215 × 115 × 50	215 × 115 × 50	215 × 115 × 50
	inch	8.46 × 4.53 × 1.97	8.46 × 4.53 × 1.97	8.46 × 4.53 × 1.97	8.46 × 4.53 × 1.97	8.46 × 4.53 × 1.97
Unit Weight	kg	0.63	0.82	0.82	0.82	0.82
	lb	1.39	1.81	1.81	1.81	1.81
Cooling System		Convection	Forced Air (Built-in Fan)			
MTBF ²⁾		> 700,000 hrs	> 700,000 hrs	> 700,000 hrs	> 700,000 hrs	> 700,000 hrs
ENVIRONMENT						
Operating Temperature ³⁾		-10°C to +60°C	-10°C to +70°C			
Storage Temperature		-25°C to +85°C				
Operating Humidity		5 to 95% RH (Non-Condensing)				
Operating Altitude		0 to 5,000 m (0 to 16,400 ft)				

Dimensions Reference

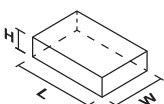

Notes

- 1) At 25°C ambient temperature by vertical mounting orientation.
- 2) MTBF as per Telcordia SR-332 (Confidence level: 90%, I/P: 100Vac, O/P: 100% load, Ta: 35°C). For PMT-24V350W1A□ models, MTBF calculations do not include fan life time.
- 3) Refer power de-rating in the product datasheet.
- 4) All parameters are specified at 25°C ambient temperature unless otherwise indicated.



PMT

Features

- AC input voltage range selectable by switch
- Conforms to harmonic current IEC/EN 61000-3-2, Class A for selected models
- High MTBF > 700,000 hrs per Telcordia SR-332
- Short Circuit / Overvoltage / Overload / Over Temperature Protections
- Versatile configuration options:
 - L Frame
 - Enclosed

Specifications

OUTPUT	PMT-36V350W1A□	PM□-48V150W1A□	PMT-48V350W1A□	PM□-D1V100W1A□	PM□-D2V100W1A□
Output Voltage	36V	48V	48V	V1: 12V, V2: 5V	V1: 24V, V2: 5V
Output Voltage Range	32.4-39.6V	45.6-52.8V	43.2-52.8V	V1: 10.8-13.2V	V1: 21.6-26.4V
Output Current	9.7A	3.3A	7.3A	V1: 7.0A, V2: 3.0A	V1: 3.5A, V2: 3.0A
Output Power	349.2W	158.4W	350W	V1: 84W, V2: 15W	V1: 84W, V2: 15W
PARD (20MHz)	< 240mVpp	< 200mVpp	< 240mVpp	V1: 120mVpp, V2: 80mVpp	V1: 120mVpp, V2: 80mVpp
Hold-up Time	115Vac	16ms typ.	20ms typ.	16ms typ.	20ms typ.
	230Vac	20ms typ.	24ms typ.	20ms typ.	25ms typ.
INPUT					
Phase Input	Single Phase				
Input Voltage Range	90-132Vac, 180-264Vac (Selectable by Switch)			88-132Vac, 176-264Vac (Selectable by Switch)	
Input Frequency	47-63Hz				
Input Current	115Vac	7.0A typ.	3.0A typ.	7.0A typ.	2.0A typ.
	230Vac	4.0A typ.	2.0A typ.	4.0A typ.	1.2A typ.
Efficiency ¹⁾ at 100% Load	230Vac	87.5% typ.	89.0% typ.	87.5% typ.	84.0% typ.
Max Inrush Current (Cold Start)	115Vac	40A typ.	-	40A typ.	-
	230Vac	60A typ.	45A typ.	60A typ.	45A typ.
Power Factor	NA	Conform to EN 61000-3-2	NA	Conform to EN 61000-3-2	
Leakage Current	240Vac	< 3.5mA	< 0.5mA	< 3.5mA	< 0.25mA
MECHANICAL					
Case Cover / Chassis	Aluminium	SGCC / Aluminium	Aluminium	SGCC / Aluminium	
Dimensions (L × W × H)	mm	215 × 115 × 50	178 × 97 × 38	215 × 115 × 50	178 × 97 × 38
	inch	8.46 × 4.53 × 1.97	7.01 × 3.82 × 1.50	8.46 × 4.53 × 1.97	7.01 × 3.82 × 1.50
Unit Weight	kg	0.83	0.48	0.83	0.42
	lb	1.83	1.06	1.83	0.93
Cooling System	Forced Air (Built-in Fan)		Convection	Forced Air (Built-in Fan)	Convection
MTBF ²⁾	> 700,000 hrs		> 700,000 hrs	> 700,000 hrs	> 700,000 hrs
ENVIRONMENT					
Operating Temperature ³⁾	-10°C to +70°C				
Storage Temperature	-25°C to +85°C				
Operating Humidity	5 to 95% RH (Non-Condensing)				
Operating Altitude	0 to 5,000 m (0 to 16,400 ft)				

Dimensions Reference

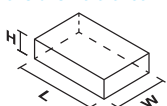

Notes

- 1) At 25°C ambient temperature by vertical mounting orientation.
- 2) MTBF as per Telcordia SR-332 (Confidence level: 90%, I/P: 100Vac, O/P: 100% load, Ta: 35°C). For PMT-36V350W1A□ and PMT-48V350W1A□ models, MTBF calculations does not include fan life time.
- 3) Refer power de-rating in the product datasheet.
- 4) All parameters are specified at 25°C ambient temperature unless otherwise indicated.

PMT2

Features

- Household appliance approvals to IEC/EN 60335-1, IEC/EN 61558-1 and IEC/EN 61558-2-16 (only 35W-150W)
- Universal AC input voltage range (except 150W & 350W)
- No load power consumption
- Low profile design: 30mm height
- Over Voltage Category III (only 35W-150W)
- Cold start at -40°C



Specifications

		COMING SOON		COMING SOON		COMING SOON		
OUTPUT		PMT-12V35W2BA□	PMT-12V50W2BA□	PMT-12V75W2BA□	PMT-12V100W2BA□	PMT-12V150W2BA□	PMT-12V350W2B□□	
Output Voltage		12V	12V	12V	12V	12V	12V	
Output Voltage Range		10.8-13.2V	10.8-13.2V	10.8-13.2V	10.8-13.2V	10.8-13.2V	10.8-13.2V	
Output Current		3.0A	4.2A	6.0A	8.5A	12.5A	29.0A (43.5A for 1s)	
Output Power		36W	50.4W	72W	102W	150W	348W	
PARD (20MHz)		< 120mVpp @ 0°C to 50°C, < 360mVpp @ -30°C to 0°C					< 150mVpp @ 0°C to 50°C, < 450mVpp @ -30°C to 0°C	
Hold-up Time	115Vac	5ms typ.	15ms typ.	5ms typ.	5ms typ.	30ms typ.	12ms typ.	
	230Vac	20ms typ.	70ms typ.	20ms typ.	40ms typ.		16ms typ.	
INPUT								
Phase Input		Single Phase						
Input Voltage Range		90-264Vac				90-132Vac, 180-264Vac (Selectable by Switch)		
Input Frequency		47-63Hz						
Input Current	115Vac	0.70A typ.	0.95A typ.	1.4A typ.	1.9A typ.	3.0A typ.	6.8A typ.	
	230Vac	0.42A typ.	0.55A typ.	0.85A typ.	1.2A typ.	1.7A typ.	3.4A typ.	
Efficiency ¹⁾ at 100% Load	230Vac	86.0% typ.	86.0% typ.	88.0% typ.	87.0% typ.	85.8% typ.	85.0% typ.	
Max Inrush Current (Cold Start)	230Vac	45A typ.	45A typ.	65A typ.	55A typ.	30A typ.	60A typ.	
Power Factor		NA						
Leakage Current (50Hz)	240Vac	< 0.75mA	< 0.75mA	< 0.75mA	< 0.75mA	< 0.75mA	2mA typ.	
MECHANICAL								
Case Cover / Chassis		SGCC / SGCC			SGCC / Aluminium			
Dimensions (L × W × H)	mm	99 × 82 × 30	99 × 82 × 30	99 × 97 × 30	129 × 97 × 30	159 × 97 × 30	215 × 115 × 30	
	inch	3.90 × 3.23 × 1.18	3.90 × 3.23 × 1.18	3.90 × 3.82 × 1.18	5.08 × 3.82 × 1.18	6.26 × 3.82 × 1.18	8.45 × 4.52 × 1.18	
Unit Weight	kg	TBA	0.18	TBA	0.29	0.35	TBA	
	lb		0.39		0.63	0.78		
Cooling System		Convection						
MTBF ²⁾		> 700,000 hrs	> 700,000 hrs	> 700,000 hrs	> 700,000 hrs	> 700,000 hrs	> 700,000 hrs	
ENVIRONMENT								
Operating Temperature ³⁾		-30°C to +70°C						
Storage Temperature		-40°C to +85°C						
Operating Humidity		5 to 95% RH (Non-Condensing)						
Operating Altitude		0 to 5,000 m (0 to 16,400 ft)						

Dimensions Reference

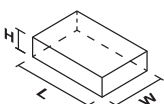

Notes

- 1) At 25°C ambient temperature by vertical mounting orientation.
- 2) MTBF as per Telcordia SR-332 (Confidence level: 90%, I/P: 230Vac, O/P: 100% load).
- 3) Refer power de-rating in the product datasheet.
- 4) All parameters are specified at 25°C ambient temperature unless otherwise indicated.

PMT2

Features

- Household appliance approvals to IEC/EN 60335-1, IEC/EN 61558-1 and IEC/EN 61558-2-16
- Universal AC input voltage range (except 150W)
- No load power consumption
- Low profile design: 30mm height
- Over Voltage Category III
- Cold start at -40°C



Specifications

	NEW	NEW	COMING SOON	COMING SOON	COMING SOON
OUTPUT	PMT-15V35W2BA	PMT-15V50W2BA	PMT-15V75W2BA	PMT-15V100W2BA	PMT-15V150W2BA
Output Voltage	15V	15V	15V	15V	15V
Output Voltage Range	13.5-16.5V	13.5-16.5V	13.5-16.5V	13.5-16.5V	13.5-16.5V
Output Current	2.4A	3.4A	5.0A	7.0A	10.0A
Output Power	36W	51W	75W	105W	150W
PARD (20MHz)	< 120mVpp @ 0°C to 50°C, < 360mVpp @ -30°C to 0°C				< 150mVpp @ 0°C to 50°C, < 450mVpp @ -30°C to 0°C
Hold-up Time	115Vac	5ms typ.	15ms typ.	5ms typ.	5ms typ.
	230Vac	20ms typ.	70ms typ.	20ms typ.	40ms typ.
INPUT					
Phase Input	Single Phase				
Input Voltage Range	90-264Vac				90-132Vac, 180-264Vac (Selectable by Switch)
Input Frequency	47-63Hz				
Input Current	115Vac	0.70A typ.	0.95A typ.	1.4A typ.	1.9A typ.
	230Vac	0.42A typ.	0.55A typ.	0.85A typ.	1.2A typ.
Efficiency ¹⁾ at 100% Load	230Vac	86.0% typ.	88.0% typ.	88.5% typ.	88.5% typ.
Max Inrush Current (Cold Start)	230Vac	45A typ.	45A typ.	65A typ.	50A typ.
Power Factor	NA				
Leakage Current (50Hz)	240Vac	< 0.75mA	< 0.75mA	< 0.75mA	< 0.75mA
MECHANICAL					
Case Cover / Chassis	SGCC / SGCC		SGCC / Aluminium		
Dimensions (L × W × H)	mm	99 × 82 × 30	99 × 82 × 30	99 × 97 × 30	129 × 97 × 30
	inch	3.90 × 3.23 × 1.18	3.90 × 3.23 × 1.18	3.90 × 3.82 × 1.18	5.08 × 3.82 × 1.18
Unit Weight	kg	TBA	0.18	TBA	0.29
	lb	TBA	0.39	TBA	0.63
Cooling System	Convection				
MTBF ²⁾	> 700,000 hrs	> 700,000 hrs	> 700,000 hrs	> 700,000 hrs	> 700,000 hrs
ENVIRONMENT					
Operating Temperature ³⁾	-30°C to +70°C				
Storage Temperature	-40°C to +85°C				
Operating Humidity	5 to 95% RH (Non-Condensing)				
Operating Altitude	0 to 5,000 m (0 to 16,400 ft)				

Dimensions Reference

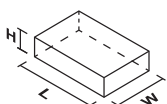

Notes

- 1) At 25°C ambient temperature by vertical mounting orientation.
- 2) MTBF as per Telcordia SR-332 (Confidence level: 90%, I/P: 230Vac, O/P: 100% load).
- 3) Refer power de-rating in the product datasheet.
- 4) All parameters are specified at 25°C ambient temperature unless otherwise indicated.

PMT2

Features

- Household appliance approvals to IEC/EN 60335-1, IEC/EN 61558-1 and IEC/EN 61558-2-16 (only 35W-150W)
- Universal AC input voltage range (except 150W & 350W)
- No load power consumption
- Low profile design: 30mm height
- Over Voltage Category III (only 35W-150W)
- Cold start at -40°C



Specifications

		COMING SOON		COMING SOON		COMING SOON	
OUTPUT		PMT-24V35W2BA	PMT-24V50W2BA	PMT-24V75W2BA□	PMT-24V100W2BA□	PMT-24V150W2BA□	PMT-24V350W2B□□
Output Voltage		24V	24V	24V	24V	24V	24V
Output Voltage Range		21.6-26.4V	21.6-26.4V	21.6-26.4V	21.6-26.4V	21.6-26.4V	21.6-26.4V
Output Current		1.5A	2.2A	3.2A	4.5A	6.25A	14.6A (21.9A for 1s)
Output Power		36W	52.8W	76.8W	108W	150W	350.5W
PARD (20MHz)		< 120mVpp @ 0°C to 50°C, < 360mVpp @ -30°C to 0°C		< 150mVpp @ 0°C to 50°C, < 450mVpp @ -30°C to 0°C		< 120mVpp @ 0°C to 50°C, < 360mVpp @ -30°C to 0°C	
Hold-up Time	115Vac	5ms typ.	15ms typ.	5ms typ.	5ms typ.	30ms typ.	12ms typ.
	230Vac	20ms typ.	70ms typ.	20ms typ.	40ms typ.		16ms typ.
INPUT							
Phase Input		Single Phase					
Input Voltage Range		90-264Vac				90-132Vac, 180-264Vac (Selectable by Switch)	
Input Frequency		47-63Hz					
Input Current	115Vac	0.70A typ.	0.95A typ.	1.4A typ.	1.9A typ.	3.0A typ.	6.8A typ.
	230Vac	0.42A typ.	0.55A typ.	0.85A typ.	1.2A typ.	1.7A typ.	3.4A typ.
Efficiency ¹⁾ at 100% Load	230Vac	88.0% typ.	88.3% typ.	88.0% typ.	89.0% typ.	85.8% typ.	88.0% typ.
Max Inrush Current (Cold Start)	230Vac	45A typ.	45A typ.	65A typ.	55A typ.	30A typ.	60A typ.
Power Factor		NA					
Leakage Current (50Hz)	240Vac	< 0.75mA	< 0.75mA	< 0.75mA	< 0.75mA	< 0.75mA	2mA typ.
MECHANICAL							
Case Cover / Chassis		SGCC / SGCC			SGCC / Aluminium		
Dimensions (L × W × H)	mm	99 × 82 × 30	99 × 82 × 30	99 × 97 × 30	129 × 97 × 30	159 × 97 × 30	215 × 115 × 30
	inch	3.90 × 3.23 × 1.18	3.90 × 3.23 × 1.18	3.90 × 3.82 × 1.18	5.08 × 3.82 × 1.18	6.26 × 3.82 × 1.18	8.45 × 4.52 × 1.18
Unit Weight	kg	TBA	0.18	TBA	0.29	0.35	TBA
	lb		0.39		0.63	0.78	
Cooling System		Convection					
MTBF ²⁾		> 700,000 hrs	> 700,000 hrs	> 700,000 hrs	> 700,000 hrs	> 700,000 hrs	> 700,000 hrs
ENVIRONMENT							
Operating Temperature ³⁾		-30°C to +70°C					
Storage Temperature		-40°C to +85°C					
Operating Humidity		5 to 95% RH (Non-Condensing)					
Operating Altitude		0 to 5,000 m (0 to 16,400 ft)					

Dimensions Reference

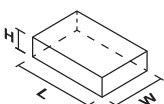

Notes

- 1) At 25°C ambient temperature by vertical mounting orientation.
- 2) MTBF as per Telcordia SR-332 (Confidence level: 90%, I/P: 230Vac, O/P: 100% load).
- 3) Refer power de-rating in the product datasheet.
- 4) All parameters are specified at 25°C ambient temperature unless otherwise indicated.

PMT2

Features

- Household appliance approvals to IEC/EN 60335-1, IEC/EN 61558-1 and IEC/EN 61558-2-16
- Universal AC input voltage range (except 150W)
- No load power consumption
- Low profile design: 30mm height
- Over Voltage Category III
- Cold start at -40°C



Specifications

	NEW	NEW	COMING SOON	COMING SOON	COMING SOON
OUTPUT	PMT-30V35W2BA	PMT-30V50W2BA	PMT-30V75W2BA	PMT-30V100W2BA	PMT-30V150W2BA
Output Voltage	30V	30V	30V	30V	30V
Output Voltage Range	27-33V	27-33V	27-33V	27-33V	27-33V
Output Current	1.2A	1.9A	2.5A	3.5A	5.0A
Output Power	36W	57W	75W	105W	150W
PARD (20MHz)	< 150mVpp @ 0°C to 50°C, < 450mVpp @ -30°C to 0°C				< 200mVpp @ 0°C to 50°C, < 600mVpp @ -30°C to 0°C
Hold-up Time	115Vac	5ms typ.	15ms typ.	5ms typ.	5ms typ.
	230Vac	20ms typ.	70ms typ.	20ms typ.	40ms typ.
INPUT					
Phase Input	Single Phase				
Input Voltage Range	90-264Vac				90-132Vac, 180-264Vac (Selectable by Switch)
Input Frequency	47-63Hz				
Input Current	115Vac	0.70A typ.	0.95A typ.	1.4A typ.	1.9A typ.
	230Vac	0.42A typ.	0.55A typ.	0.85A typ.	1.2A typ.
Efficiency ¹⁾ at 100% Load	230Vac	88.0% typ.	88.0% typ.	90.0% typ.	90.0% typ.
Max Inrush Current (Cold Start)	230Vac	45A typ.	45A typ.	65A typ.	50A typ.
Power Factor	NA				
Leakage Current (50Hz)	240Vac	< 0.75mA	< 0.75mA	< 0.75mA	< 0.75mA
MECHANICAL					
Case Cover / Chassis	SGCC / SGCC		SGCC / Aluminium		
Dimensions (L × W × H)	mm	99 × 82 × 30	99 × 82 × 30	99 × 97 × 30	129 × 97 × 30
	inch	3.90 × 3.23 × 1.18	3.90 × 3.23 × 1.18	3.90 × 3.82 × 1.18	5.08 × 3.82 × 1.18
Unit Weight	kg	TBA	0.18	TBA	0.29
	lb	TBA	0.39	TBA	0.63
Cooling System	Convection				
MTBF ²⁾	> 700,000 hrs	> 700,000 hrs	> 700,000 hrs	> 700,000 hrs	> 700,000 hrs
ENVIRONMENT					
Operating Temperature ³⁾	-30°C to +70°C				
Storage Temperature	-40°C to +85°C				
Operating Humidity	5 to 95% RH (Non-Condensing)				
Operating Altitude	0 to 5,000 m (0 to 16,400 ft)				

Dimensions Reference

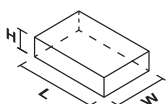

Notes

- 1) At 25°C ambient temperature by vertical mounting orientation.
- 2) MTBF as per Telcordia SR-332 (Confidence level: 90%, I/P: 230Vac, O/P: 100% load).
- 3) Refer power de-rating in the product datasheet.
- 4) All parameters are specified at 25°C ambient temperature unless otherwise indicated.

PMT2

Features

- Household appliance approvals to IEC/EN 60335-1, IEC/EN 61558-1 and IEC/EN 61558-2-16 (only 35W-150W)
- Universal AC input voltage range (except 150W & 350W)
- No load power consumption
- Low profile design: 30mm height
- Over Voltage Category III (only 35W-150W)
- Cold start at -40°C



Specifications

	NEW	NEW	COMING SOON	NEW	NEW	COMING SOON
OUTPUT	PMT-36V35W2BA	PMT-36V50W2BA	PMT-36V75W2BA	PMT-36V100W2BA	PMT-36V150W2BA	PMT-36V350W2BR
Output Voltage	36V	36V	36V	36V	36V	36V
Output Voltage Range	32.4-39.6V	32.4-39.6V	32.4-39.6V	32.4-39.6V	32.4-39.6V	32.4-39.6V
Output Current	1A	1.45A	2.1A	2.8A	4.3A	9.7A (14.55A for 1s)
Output Power	36W	52.2W	75.6W	100.8W	154.8W	349.2W
PARD (20MHz)	< 200mVpp @ 0°C to 50°C, < 600mVpp @ -30°C to 0°C					
Hold-up Time	115Vac	5ms typ.	15ms typ.	5ms typ.	5ms typ.	30ms typ.
	230Vac	20ms typ.	70ms typ.	20ms typ.	40ms typ.	16ms typ.
INPUT						
Phase Input	Single Phase					
Input Voltage Range	90-264Vac				90-132Vac, 180-264Vac (Selectable by Switch)	
Input Frequency	47-63Hz					
Input Current	115Vac	0.70A typ.	0.95A typ.	1.4A typ.	1.9A typ.	3.0A typ.
	230Vac	0.42A typ.	0.55A typ.	0.85A typ.	1.2A typ.	1.7A typ.
Efficiency ¹⁾ at 100% Load	230Vac	88.0% typ.	89.0% typ.	90.5% typ.	90.5% typ.	89.0% typ.
Max Inrush Current (Cold Start)	230Vac	45A typ.	45A typ.	65A typ.	50A typ.	60A typ.
Power Factor	NA					
Leakage Current (50Hz)	240Vac	< 0.75mA	< 0.75mA	< 0.75mA	< 0.75mA	< 0.75mA
MECHANICAL						
Case Cover / Chassis	SGCC / SGCC			SGCC / Aluminium		
Dimensions (L x W x H)	mm	99 x 82 x 30	99 x 82 x 30	99 x 97 x 30	129 x 97 x 30	159 x 97 x 30
	inch	3.90 x 3.23 x 1.18	3.90 x 3.23 x 1.18	3.90 x 3.82 x 1.18	5.08 x 3.82 x 1.18	6.26 x 3.82 x 1.18
Unit Weight	kg	TBA	0.18	TBA	0.29	0.35
	lb	TBA	0.39	TBA	0.63	0.78
Cooling System	Convection					
MTBF ²⁾	> 700,000 hrs	> 700,000 hrs	> 700,000 hrs	> 700,000 hrs	> 700,000 hrs	> 700,000 hrs
ENVIRONMENT						
Operating Temperature ³⁾	-30°C to +70°C					
Storage Temperature	-40°C to +85°C					
Operating Humidity	5 to 95% RH (Non-Condensing)					
Operating Altitude	0 to 5,000 m (0 to 16,400 ft)					

Dimensions Reference

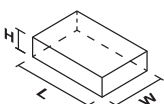

Notes

- 1) At 25°C ambient temperature by vertical mounting orientation.
- 2) MTBF as per Telcordia SR-332 (Confidence level: 90%, I/P: 230Vac, O/P: 100% load).
- 3) Refer power de-rating in the product datasheet.
- 4) All parameters are specified at 25°C ambient temperature unless otherwise indicated.

PMT2

Features

- Household appliance approvals to IEC/EN 60335-1, IEC/EN 61558-1 and IEC/EN 61558-2-16 (only 35W-150W)
- Universal AC input voltage range (except 150W & 350W)
- No load power consumption
- Low profile design: 30mm height
- Over Voltage Category III (only 35W-150W)
- Cold start at -40°C



Specifications

	NEW	NEW	COMING SOON	COMING SOON	COMING SOON	COMING SOON
OUTPUT	PMT-48V35W2BA	PMT-48V50W2BA	PMT-48V75W2BA	PMT-48V100W2BA	PMT-48V150W2BA	PMT-48V350W2BR
Output Voltage	48V	48V	48V	48V	48V	36V
Output Voltage Range	43.2-52.8V	43.2-52.8V	43.2-52.8V	43.2-52.8V	43.2-52.8V	32.4-39.6V
Output Current	0.8A	1.1A	1.6A	2.3A	3.3A	7.3A (10.95A for 1s)
Output Power	38.4W	52.8W	76.8W	110.4W	158.4W	350.4W
PARD (20MHz)	< 200mVpp @ 0°C to 50°C, < 600mVpp @ -30°C to 0°C					
Hold-up Time	115Vac	5ms typ.	15ms typ.	5ms typ.	5ms typ.	30ms typ.
	230Vac	20ms typ.	70ms typ.	20ms typ.	40ms typ.	
INPUT						
Phase Input	Single Phase					
Input Voltage Range	90-264Vac				90-132Vac, 180-264Vac (Selectable by Switch)	
Input Frequency	47-63Hz					
Input Current	115Vac	0.70A typ.	0.95A typ.	1.4A typ.	1.9A typ.	3.0A typ.
	230Vac	0.42A typ.	0.55A typ.	0.85A typ.	1.2A typ.	1.7A typ.
Efficiency ¹⁾ at 100% Load	230Vac	88.0% typ.	90.0% typ.	91.0% typ.	91.0% typ.	89.0% typ.
Max Inrush Current (Cold Start)	230Vac	45A typ.	45A typ.	65A typ.	50A typ.	60A typ.
Power Factor	NA					
Leakage Current (50Hz)	240Vac	< 0.75mA	< 0.75mA	< 0.75mA	< 0.75mA	< 0.75mA
MECHANICAL						
Case Cover / Chassis	SGCC / SGCC		SGCC / Aluminium			
Dimensions (L x W x H)	mm	99 x 82 x 30	99 x 82 x 30	99 x 97 x 30	129 x 97 x 30	159 x 97 x 30
	inch	3.90 x 3.23 x 1.18	3.90 x 3.23 x 1.18	3.90 x 3.82 x 1.18	5.08 x 3.82 x 1.18	6.26 x 3.82 x 1.18
Unit Weight	kg	TBA	0.18	TBA	0.29	0.35
	lb	TBA	0.39	TBA	0.63	0.78
Cooling System	Convection					
MTBF ²⁾	> 700,000 hrs	> 700,000 hrs	> 700,000 hrs	> 700,000 hrs	> 700,000 hrs	> 700,000 hrs
ENVIRONMENT						
Operating Temperature ³⁾	-30°C to +70°C					
Storage Temperature	-40°C to +85°C					
Operating Humidity	5 to 95% RH (Non-Condensing)					
Operating Altitude	0 to 5,000 m (0 to 16,400 ft)					

Dimensions Reference

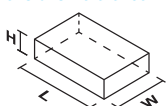

Notes

- 1) At 25°C ambient temperature by vertical mounting orientation.
- 2) MTBF as per Telcordia SR-332 (Confidence level: 90%, I/P: 230Vac, O/P: 100% load).
- 3) Refer power de-rating in the product datasheet.
- 4) All parameters are specified at 25°C ambient temperature unless otherwise indicated.

PMT2

Features

- Universal AC input voltage range
- No load power consumption
- Low profile design: 30mm height
- Over Voltage Category III
- Cold start at -40°C
- Conforms to harmonic current IEC/EN 61000-3-2, Class A



Specifications

		COMING SOON	COMING SOON
OUTPUT		PMT-D1V75W2BA□	PMT-D2V75W2BA□
Output Voltage		V1: 12V, V2: 5V	V1: 24V, V2: 5V
Output Voltage Range		12V: 10.2-13.2V	24V: 21.6-26.4V
Output Current		V1: 4.2A, V2: 5.0A	V1: 2.1A, V2: 5.0A
Output Power		75.4W	75.4W
PARD (20MHz)		V1: 120mVpp typ. V2: 100mVpp typ.	V1: 240mVpp typ. V2: 100mVpp typ.
Hold-up Time	115Vac	5ms typ.	5ms typ.
	230Vac	20ms typ.	20ms typ.
INPUT			
Phase Input	Single Phase		
Input Voltage Range	90-264Vac		
Input Frequency	47-63Hz		
Input Current	115Vac	1.4A typ.	1.4A typ.
	230Vac	0.85A typ.	0.85A typ.
Efficiency ¹⁾ at 100% Load	230Vac	83.0% typ.	84.5% typ.
Max Inrush Current (Cold Start)	230Vac	65A typ.	65A typ.
Power Factor	NA		
Leakage Current (50Hz)	240Vac	0.75mA typ.	0.75mA typ.
MECHANICAL			
Case Cover / Chassis	SGCC / SGCC		
Dimensions (L × W × H)	mm	129 × 97 × 30	129 × 97 × 30
	inch	5.08 × 3.82 × 1.18	5.08 × 3.82 × 1.18
Unit Weight	kg	TBA	TBA
	lb		
Cooling System	Convection		
MTBF ²⁾	> 700,000 hrs		> 700,000 hrs
ENVIRONMENT			
Operating Temperature ³⁾	-30°C to +70°C		
Storage Temperature	-40°C to +85°C		
Operating Humidity	5 to 95% RH (Non-Condensing)		
Operating Altitude	0 to 5,000 m (0 to 16,400 ft)		

Dimensions Reference

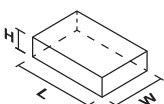

Notes

- 1) At 25°C ambient temperature by vertical mounting orientation.
- 2) MTBF as per Telcordia SR-332 (Confidence level: 90%, I/P: 230Vac, O/P: 100% load).
- 3) Refer power de-rating in the product datasheet.
- 4) All parameters are specified at 25°C ambient temperature unless otherwise indicated.

PMC

Features

- Universal AC input voltage range
- Power will not de-rate for the entire input voltage range
- Full corrosion resistant aluminium casing (except PMC-05V015W1AA)
- Conforms to harmonic current IEC/EN 61000-3-2, Class A
- High MTBF > 700,000 hrs per Telcordia SR-332
- Safety approval according to IEC/EN/UL 60950-1 (ITE standard) and EMI to EN 55032, Class B



Specifications

OUTPUT		PMC-05V015W1AA	PMC-05V035W1A□	PMC-05V050W1AA
Output Voltage		5V	5V	5V
Output Voltage Range		4.75-5.50V	4.75-5.50V	4.75-5.50V
Output Current		0-3.0A	0-7.0A	0-10.0A
Output Power		15W	35W	50W
PARD (20MHz)		< 70mVpp		
Hold-up Time	115Vac	> 15ms	> 15ms	> 15ms
	230Vac	> 80ms	> 80ms	> 80ms
INPUT				
Phase Input		Single Phase		
Input Voltage Range		85-264Vac (DC input range 125-375Vdc) ¹⁾		
Input Frequency		47-63Hz		
Input Current	115Vac	< 0.32A	< 0.90A	< 1.10A
	230Vac	< 0.22A	< 0.80A	< 0.70A
Efficiency ²⁾ at 100% Load	115Vac	> 78.0%	> 78.0%	> 79.0%
	230Vac	> 79.0%	> 79.0%	> 79.0%
Max Inrush Current (Cold Start)	115Vac	< 30A	< 30A	< 30A
	230Vac	< 65A	< 60A	< 65A
Power Factor		Conform to EN 61000-3-2		
Leakage Current	240Vac	< 1mA	< 1mA	< 1mA
MECHANICAL				
Case Cover / Chassis		SECC Steel	Aluminium	
Dimensions (L × W × H)	mm	77 × 51 × 28	98 × 97 × 38	128 × 97 × 38
	inch	3.03 × 2.01 × 1.10	3.86 × 3.82 × 1.50	5.04 × 3.82 × 1.50
Unit Weight	kg	0.16	0.18	0.26
	lb	0.35	0.40	0.57
Cooling System		Convection		
MTBF ³⁾		> 700,000 hrs	> 700,000 hrs	> 700,000 hrs
ENVIRONMENT				
Operating Temperature ⁴⁾		-10°C to +70°C		
Storage Temperature		-25°C to +85°C		
Operating Humidity		5 to 95% RH (Non-Condensing)		
Operating Altitude		0 to 3,000 m (0 to 9,840 ft)		

Dimensions Reference

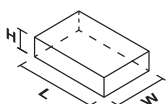

Notes

- 1) All models are certified for DC input except PMC-05V015W1AA which still fulfills the test conditions of this range. DC input safety approval can be obtained upon request.
- 2) At 25°C ambient temperature by vertical mounting orientation.
- 3) MTBF as per Telcordia SR-332 (Confidence level: 90%, I/P: 115Vac, O/P: 100% load) for vertical mounting orientation.
- 4) Refer power de-rating in the product datasheet.
- 5) All parameters are specified at 25°C ambient temperature unless otherwise indicated.

PMC

Features

- Universal AC input voltage range
- Power will not de-rate for the entire input voltage range
- Full corrosion resistant aluminium casing
- Conforms to harmonic current IEC/EN 61000-3-2, Class A
- High MTBF > 700,000 hrs per Telcordia SR-332
- Safety approval according to IEC/EN/UL 60950-1 (ITE standard) and EMI to EN 55032, Class B
- Also available: IP20 connector



Specifications

OUTPUT		PMC-12V035W1A□	PMC-12V050W1A□	PMC-12V060W1NA	PMC-12V100W1AA
Output Voltage		12V	12V	12V	12V
Output Voltage Range		11-14V	11-14V	12-14V	11-14V
Output Current		0-3.0A	0-4.17A	0-5.0A	0-8.33A
Output Power		35W	50W	60W	100W
PARD (20MHz)		< 100mVpp			
Hold-up Time	115Vac	> 15ms	> 15ms	> 15ms	> 15ms
	230Vac	> 80ms	> 80ms	> 80ms	> 80ms
INPUT					
Phase Input		Single Phase			
Input Voltage Range		85-264Vac (DC input range 125-375Vdc) ¹⁾			
Input Frequency		47-63Hz			
Input Current	115Vac	< 0.75A	< 1.10A	< 1.35A	< 2.00A
	230Vac	< 0.50A	< 0.70A	< 0.90A	< 1.10A
Efficiency ²⁾ at 100% Load	115Vac	> 85.0%	> 84.0%	> 86.0%	> 84.0%
	230Vac	> 86.0%	> 84.0%	> 87.0%	> 86.0%
Max Inrush Current (Cold Start)	115Vac	< 30A	< 30A	< 50A	< 60A
	230Vac	< 60A	< 65A	< 100A	< 130A
Power Factor		Conform to EN 61000-3-2			
Leakage Current	240Vac	< 1mA	< 1mA	< 1mA	< 1mA
MECHANICAL					
Case Cover / Chassis		Aluminium			
Dimensions (L × W × H)	mm	98 × 97 × 38	128 × 97 × 38	128 × 97 × 38	158 × 97 × 38
	inch	3.86 × 3.82 × 1.50	5.04 × 3.82 × 1.50	5.04 × 3.82 × 1.50	6.22 × 3.82 × 1.50
Unit Weight	kg	0.21	0.26	0.28	0.45
	lb	0.46	0.57	0.62	0.99
Cooling System		Convection			
MTBF ³⁾		> 700,000 hrs	> 700,000 hrs	> 700,000 hrs	> 700,000 hrs
ENVIRONMENT					
Operating Temperature ⁴⁾		-10°C to +70°C		-20°C to +70°C	
Storage Temperature		-25°C to +85°C			
Operating Humidity		5 to 95% RH (Non-Condensing)			
Operating Altitude		0 to 3,000 m (0 to 9,840 ft)			

Dimensions Reference

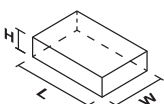

Notes

- 1) All models are certified for DC input.
- 2) At 25°C ambient temperature by vertical mounting orientation.
- 3) MTBF as per Telcordia SR-332 (Confidence level: 90%, I/P: 115Vac, O/P: 100% load) for vertical mounting orientation.
- 4) Refer power de-rating in the product datasheet.
- 5) All parameters are specified at 25°C ambient temperature unless otherwise indicated.



PMC

Features

- Universal AC input voltage range
- Power will not de-rate for the entire input voltage range
- Full corrosion resistant aluminium casing (except PMC-12V600W1BA)
- Conforms to harmonic current IEC/EN 61000-3-2, Class A
- High MTBF > 700,000 hrs per Telcordia SR-332

Specifications

OUTPUT		PMC-12V150W1BQ	PMC-12V600W1BA
Output Voltage		12V	12V
Output Voltage Range		11-14V	10.8-13.2V
Output Current		0-12.5A	0-50A
Output Power		150W	600W
PARD (20MHz)		< 100mVpp	< 240mVpp
Hold-up Time (100% Load)	115Vac	> 30ms	> 20ms
	230Vac		
INPUT			
Phase Input	Single Phase		
Input Voltage Range	85-264Vac (DC input range 125-375Vdc) ¹⁾		85-264Vac (DC input range 120-375Vdc) ¹⁾
Input Frequency	47-63Hz		
Input Current	115Vac	< 1.70A @ 115Vac,	< 6.5A @ 115Vac,
	230Vac	< 1.00A @ 230Vac	< 3.2A @ 230Vac
Efficiency ²⁾ at 100% Load	115Vac	> 87.0% @ 115Vac,	> 85.5% @ 115Vac,
	230Vac	> 88.0% @ 230Vac	> 89.0% @ 230Vac
Max Inrush Current (Cold Start)	115Vac	< 60A @ 115Vac,	< 10A @ 115Vac,
	230Vac	< 120A @ 230Vac	< 20A @ 230Vac
Power Factor	115Vac	> 0.99 @ 115Vac,	> 0.98 @ 115Vac,
	230Vac	> 0.90 @ 230Vac	> 0.95 @ 230Vac
Leakage Current	240Vac	< 1mA	< 1mA
MECHANICAL			
Case Cover / Chassis	Aluminium		SECC Steel
Dimensions (L × W × H)	mm	178 × 97 × 38	215 × 120 × 61
	inch	7.01 × 3.82 × 1.50	8.46 × 4.72 × 2.4
Unit Weight	kg	0.54	1.51
	lb	1.19	3.33
Cooling System	Convection		
MTBF ³⁾	> 700,000 hrs		Forced Air (Built-in Fan) > 700,000 hrs
ENVIRONMENT			
Operating Temperature	-10°C to +70°C		-20°C to +70°C
Storage Temperature	-25°C to +85°C		-40°C to +85°C
Operating Humidity	5 to 95% RH (Non-Condensing)		
Operating Altitude	0 to 3,000 m (0 to 9,840 ft)		

Dimensions Reference

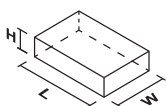

Notes

- 1) All models fulfill the test conditions for this range. DC input safety approval can be obtained upon request.
- 2) At 25°C ambient temperature by vertical mounting orientation.
- 3) MTBF as per Telcordia SR-332 (Confidence level: 90%, I/P: 115Vac, O/P: 100% load) for vertical mounting orientation. For PMC-12V600W1BA, MTBF calculations do not include fan life time.
- 4) Refer power de-rating in the product datasheet.
- 5) All parameters are specified at 25°C ambient temperature unless otherwise indicated.



PMC

Features

- Universal AC input voltage range
- Power will not de-rate for the entire input voltage range
- Full corrosion resistant aluminium casing
- Conforms to harmonic current IEC/EN 61000-3-2, Class A
- High MTBF > 700,000 hrs per Telcordia SR-332
- Safety approval according to IEC/EN/UL 60950-1 (ITE standard) and EMI to EN 55032, Class B
- Also available: IP20 connector

Specifications

OUTPUT		PMC-24V035W1A□	PMC-24V050W1A□	PMC-24V075W1A□	PMC-24V100W1A□	PMC-24V150W1A□
Output Voltage		24V	24V	24V	24V	24V
Output Voltage Range		22-28V	22-28V	22-28V	22-28V	22-28V
Output Current		0-1.46A	0-2.1A	0-3.12A	0-4.17A	0-6.25A
Output Power		35W	50W	75W	100W	150W
PARD (20MHz)		< 150mVpp		< 100mVpp	< 150mVpp	< 100mVpp
Hold-up Time	115Vac	> 15ms	> 15ms	> 15ms	> 15ms	> 15ms
	230Vac	> 80ms	> 90ms	> 90ms	> 90ms	> 80ms
INPUT						
Phase Input		Single Phase				
Input Voltage Range		85-264Vac (DC input range 125-375Vdc) ¹⁾				
Input Frequency		47-63Hz				
Input Current	115Vac	< 0.75A	< 1.10A	< 1.50A	< 2.00A	< 3.10A
	230Vac	< 0.50A	< 0.70A	< 1.00A	< 1.10A	< 2.00A
Efficiency ²⁾ at 100% Load	115Vac	> 85.0%	> 86.0%	> 86.0%	> 86.0%	> 87.0%
	230Vac	> 85.0%	> 86.0%	> 86.0%	> 86.0%	> 88.0%
Max Inrush Current (Cold Start)	115Vac	< 30A	< 30A	< 40A	< 50A	< 60A
	230Vac	< 60A	< 60A	< 80A	< 100A	< 120A
Power Factor		Conform to EN 61000-3-2				NA
Leakage Current	240Vac	< 1mA				
MECHANICAL						
Case Cover / Chassis		Aluminium				
Dimensions (L × W × H)	mm	128 × 97 × 38	128 × 97 × 38	128 × 97 × 38	158 × 97 × 38	178 × 97 × 38
	inch	5.04 × 3.82 × 1.50	5.04 × 3.82 × 1.50	5.04 × 3.82 × 1.50	6.22 × 3.82 × 1.50	7.01 × 3.82 × 1.50
Unit Weight	kg	0.24	0.26	0.30	0.41	0.48
	lb	0.53	0.57	0.66	0.90	1.06
Cooling System		Convection				
MTBF ³⁾		> 700,000 hrs	> 700,000 hrs	> 700,000 hrs	> 700,000 hrs	> 700,000 hrs
ENVIRONMENT						
Operating Temperature		-10°C to +70°C				
Storage Temperature		-25°C to +85°C				
Operating Humidity		5 to 95% RH (Non-Condensing)				
Operating Altitude		0 to 3,000 m (0 to 9,840 ft)				0 to 5,000 m (0 to 16,400 ft)

Dimensions Reference

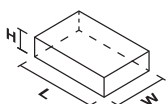

Notes

- 1) All models are certified for DC input.
- 2) At 25°C ambient temperature by vertical mounting orientation.
- 3) MTBF as per Telcordia SR-332 (Confidence level: 90%, I/P: 115Vac, O/P: 100% load) for vertical mounting orientation.
- 4) Refer power de-rating in the product datasheet.
- 5) All parameters are specified at 25°C ambient temperature unless otherwise indicated.



PMC

Features

- Universal AC input voltage range
- Power will not de-rate for the entire input voltage range
- Full corrosion resistant aluminium casing (except PMC-24V600W1BA)
- Conforms to harmonic current IEC/EN 61000-3-2, Class A
- High MTBF > 700,000 hrs per Telcordia SR-332
- Safety approval according to IEC/EN/UL 60950-1 (ITE standard) and EMI to EN 55032, Class B
- Also available: IP20 and Front Face connectors

Specifications

OUTPUT		PMC-24V150W2AA	PMC-24V150W1B□	PMC-24V300W1BA	PMC-24V600W1BA	PMC-DSPV100W1A
Output Voltage		24V	24V	V1: 24V, V2 SB: 12V	24V	V1: 24V, V2: 5V
Output Voltage Range		22-28V	22-28V	V1: 22-28V	21.6-26.4V	V1: 22.8-26.4V
Output Current		0-6.25A	0-6.25A	V1: 12.5A (0-12.5A) V2 SB: 0.5A (0-0.5A)	0-25.0A (50.0A for 5s)	V1: 2.7A (0.3-4.0A) V2: 7.0A (0.8-7.0A)
Output Power		150W	150W	300W	600W (1,200W for 5s)	100W
PARD (20MHz)		< 100mVpp		V1: < 100mVpp, V2: < 200mVpp	< 180mVpp	V1: < 200mVpp, V2: < 80mVpp
Hold-up Time	115Vac	-	> 30ms	> 15ms @ nominal input, 100% load	> 20ms	> 15ms
	230Vac	> 20ms				> 80ms
INPUT						
Phase Input		Single Phase				
Input Voltage Range		180-264Vac (DC input range 220-375Vdc) ¹⁾	85-264Vac (DC input range 125-375Vdc) ¹⁾	85-264Vac (DC input range 120-370Vdc) ¹⁾	85-264Vac (DC input range 125-375Vdc) ¹⁾	85-264Vac (DC input range 125-375Vdc) ¹⁾
Input Frequency		47-63Hz				
Input Current	115Vac	-	< 1.7A	< 4.0A	< 6.5A	< 2.0A
	230Vac	< 1.6A	< 1.0A	< 2.0A	< 3.2A	< 1.1A
Efficiency ²⁾ at 100% Load	115Vac	-	> 89.0%	> 86.0%	> 86.0%	> 84.0%
	230Vac	> 87.0%	> 91.0%	> 88.0%	> 89.0%	> 86.0%
Max Inrush Current (Cold Start)	115Vac	-	< 60A	< 35A	< 20A	< 50A
	230Vac	< 120A	< 120A	< 70A	< 40A	< 100A
Power Factor	115Vac	Conform to	> 0.99	> 0.99	> 0.99	Conform to
	230Vac	EN 61000-3-2	> 0.90	> 0.97	> 0.94	EN 61000-3-2
Leakage Current		240Vac < 1mA	< 1mA	< 1mA	< 1.5mA	< 1mA
MECHANICAL						
Case Cover / Chassis		Aluminium			SECC Steel	Aluminium
Dimensions (L x W x H)	mm	178 x 97 x 38	178 x 97 x 38	199 x 105 x 41	215 x 120 x 61	178 x 97 x 38
	inch	7.01 x 3.82 x 1.50	7.01 x 3.82 x 1.50	7.83 x 4.13 x 1.61	8.46 x 4.72 x 2.40	7.01 x 3.82 x 1.50
Unit Weight	kg	0.50	0.54	0.82	1.60	0.52
	lb	1.10	1.19	1.81	3.53	1.15
Cooling System		Convection			Forced Air (Built-in Fan)	Convection
MTBF ³⁾		> 700,000 hrs	> 700,000 hrs	> 700,000 hrs	> 300,000 hrs	> 700,000 hrs
ENVIRONMENT						
Operating Temperature ⁴⁾		-10°C to +70°C			-20°C to +70°C	-10°C to +70°C
Storage Temperature		-25°C to +85°C			-20°C to +75°C	-25°C to +85°C
Operating Humidity		5 to 95% RH (Non-Condensing)				
Operating Altitude		0 to 3,000 m (0 to 9,840 ft)	0 to 5,000 m (0 to 16,400 ft)	0 to 3,000 m (0 to 9,840 ft)		

Dimensions Reference

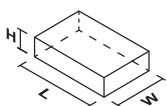

Notes

- 1) All models fulfill the test conditions for this range. DC input safety approval can be obtained upon request. While PMC-24V150W2AA and PMC-DSPV100W1A are also certified for DC input.
- 2) At 25°C ambient temperature by vertical mounting orientation.
- 3) MTBF as per Telcordia SR-332 (Confidence level: 90%, I/P: 115Vac, O/P: 100% load) for vertical mounting orientation. For PMC-24V300W1BA and PMC-24V600W1BA models, MTBF calculations do not include fan life time.
- 4) Refer power de-rating in the product datasheet.
- 5) All parameters are specified at 25°C ambient temperature unless otherwise indicated.



PMC

Features

- Universal AC input voltage range
- Power will not de-rate for the entire input voltage range
- Full corrosion resistant aluminium casing (except PMC-48V600W1BA)
- Conforms to harmonic current IEC/EN 61000-3-2, Class A
- High MTBF > 700,000 hrs per Telcordia SR-332

Specifications

OUTPUT		PMC-48V150W1BA	PMC-48V600W1BA
Output Voltage		48V	48V
Output Voltage Range		44-53V	43.2-52.8V
Output Current		0-3.125A	0-12.5A
Output Power		150W	600W
PARD (20MHz)		< 200mVpp	< 300mVpp
Hold-up Time (100% Load)	115Vac	> 30ms	> 20ms
	230Vac		
INPUT			
Phase Input		Single Phase	
Input Voltage Range		85-264Vac (DC input range 125-375Vdc) ¹⁾	85-264Vac (DC input range 120-370Vdc) ¹⁾
Input Frequency		47-63Hz	
Input Current	115Vac	< 1.7A	< 6.5A
	230Vac	< 1.0A	< 3.2A
Efficiency ²⁾ at 100% Load	115Vac	> 89.0%	> 87.0%
	230Vac	> 91.0%	> 90.0%
Max Inrush Current (Cold Start)	115Vac	< 20A	< 20A
	230Vac	< 40A	< 40A
Power Factor	115Vac	> 0.99	> 0.98
	230Vac	> 0.92	> 0.96
Leakage Current	240Vac	< 1.5mA	< 1mA
MECHANICAL			
Case Cover / Chassis		Aluminium	SECC Steel
Dimensions (L x W x H)	mm	178 x 97 x 38	215 x 120 x 61
	inch	7.01 x 3.82 x 1.50	8.46 x 4.72 x 2.4
Unit Weight	kg	0.53	1.54
	lb	1.17	3.40
Cooling System		Convection	Forced Air (Built-in Fan)
MTBF ³⁾		> 700,000 hrs	> 700,000 hrs
ENVIRONMENT			
Operating Temperature ⁴⁾		-10°C to +70°C	-20°C to +70°C
Storage Temperature		-25°C to +85°C	-40°C to +85°C
Operating Humidity		5 to 95% RH (Non-Condensing)	
Operating Altitude		0 to 5,000 m (0 to 16,400 ft)	0 to 3,000 m (0 to 9,840 ft)

Dimensions Reference

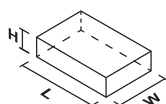

Notes

- 1) All models fulfill the test conditions for DC input. DC input safety approval can be obtained upon request.
- 2) At 25°C ambient temperature by vertical mounting orientation.
- 3) MTBF as per Telcordia SR-332 (Confidence level: 90%, I/P: 115Vac, O/P: 100% load) for vertical mounting orientation. For PMC-48V600W1BA, MTBF calculations do not include fan life time.
- 4) Refer power de-rating in the product datasheet.
- 5) All parameters are specified at 25°C ambient temperature unless otherwise indicated.

PMH

Features

- Household appliance approvals to IEC/EN 60335-1, IEC/EN 61558-1 and IEC/EN 61558-2-16
- Universal AC input voltage range
- Full power from -20°C to +50°C operation
- Full corrosion resistant aluminium casing
- High MTBF > 700,000 hrs per Telcordia SR-332
- Also available: IP20, Front Face and Harness connectors



AR

Specifications

OUTPUT	PMH-24V50WCA□	PMH-24V100WCA□	PMH-24V100WCC□	PMH-24V100WCN□
Output Voltage	24V	24V	24V	24V
Output Voltage Range	22-28V	22-28V	22-28V	22-24V
Output Current	0-2.1A	0-4.16A	0-4.16A	0-3.8A
Output Power	50W	100W	100W	91.2W
PARD (20MHz) ¹⁾	< 100mVpp @ -20°C to 70°C < 150mVpp @ < -20°C to -30°C		< 100mVpp	
Hold-up Time (100% Load)	115Vac	> 15ms	> 15ms	> 15ms
	230Vac	> 90ms	> 100ms	> 100ms
INPUT				
Phase Input	Single Phase			
Input Voltage Range	85-264Vac (DC input range 120-375Vdc) ²⁾			
Input Frequency	47-63Hz			
Input Current	115Vac	< 0.94A	< 1.90A	< 1.90A
	230Vac	< 0.59A	< 1.10A	< 1.00A
Efficiency ³⁾ at 100% Load	115Vac	> 87.0%	> 87.0%	> 87.0%
	230Vac	> 88.0%	> 89.0%	> 88.5%
Max Inrush Current (Cold Start)	115Vac	< 35A	< 50A	< 50A
	230Vac	< 70A	< 100A	< 100A
Power Factor	Conform to EN 61000-3-2			
Leakage Current	240Vac	-	< 1.2mA	< 0.5mA
	264Vac	< 0.5mA	-	< 0.75mA
MECHANICAL				
Case Cover / Chassis	Aluminium			
Dimensions (L × W × H)	mm	98 × 97 × 38	158 × 97 × 38	158 × 97 × 38
	inch	3.86 × 3.82 × 1.50	6.22 × 3.82 × 1.50	6.22 × 3.82 × 1.50
Unit Weight	kg	0.21	0.43	0.43
	lb	0.46	0.95	0.95
Cooling System	Convection			
MTBF ⁴⁾	> 700,000 hrs	> 700,000 hrs	> 700,000 hrs	> 700,000 hrs
ENVIRONMENT				
Operating Temperature ⁵⁾	-30°C to +70°C			
Storage Temperature	-30°C to +85°C			
Operating Humidity	5 to 95% RH (Non-Condensing)			
Operating Altitude	0 to 5,000 m (0 to 16,400 ft)			

Dimensions Reference

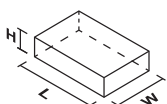

Notes

- 1) PARD is measured with an AC coupling mode, 5cm wires, and in parallel with 0.1µF ceramic capacitor & 47µF electrolytic capacitor.
- 2) All models are certified for DC input.
- 3) At 25°C ambient temperature by vertical mounting orientation.
- 4) MTBF as per Telcordia SR-332 (Confidence level: 90%, I/P: 115Vac, O/P: 100% load) for vertical mounting orientation.
- 5) Refer power de-rating in the product datasheet.
- 6) All parameters are specified at 25°C ambient temperature unless otherwise indicated.

PMH

Features



- Household appliance approvals to IEC/EN 60335-1, IEC/EN 61558-1 and IEC/EN 61558-2-16
- Universal AC input voltage range
- Full power from -20°C to +50°C operation (except PMH-24V200WCB□)
- Full corrosion resistant aluminium casing
- High MTBF > 700,000 hrs per Telcordia SR-332
- Also available: IP20, Front Face and Harness connectors

Specifications

OUTPUT		PMH-24V150WCB□	PMH-24V150WCD□	PMH-24V200WCB□
Output Voltage		24V	24V	24V
Output Voltage Range		22-28V	22-28V	22-28V
Output Current		0-6.25A	0-6.25A	0-8.33A
Output Power		150W	150W	200W
PARD (20MHz) ¹⁾		< 100mVpp		< 100mVpp @ -20°C to 70°C < 240mVpp @ < -20°C to -30°C
Hold-up Time (100% Load)	115Vac	> 40ms	> 40ms	> 20ms
	230Vac	> 50ms	> 50ms	
INPUT				
Phase Input		Single Phase		
Input Voltage Range		85-264Vac (DC input range 120-375Vdc) ²⁾		
Input Frequency		47-63Hz		
Input Current	115Vac	< 1.6A	< 1.6A	< 2.2A
	230Vac	< 0.9A	< 0.9A	< 1.2A
Efficiency ³⁾ at 100% Load	115Vac	> 89.0%	> 89.0%	> 89.5%
	230Vac	> 90.5%	> 90.5%	> 91.5%
Max Inrush Current (Cold Start)	115Vac	< 30A	< 30A	< 60A
	230Vac	< 60A	< 60A	< 120A
Power Factor	115Vac	> 0.98	> 0.98	> 0.98
	230Vac	> 0.89	> 0.89	> 0.92
Leakage Current	240Vac	< 1.2mA	< 0.75mA	-
	264Vac	-	-	< 1mA
MECHANICAL				
Case Cover / Chassis		Aluminium		
Dimensions (L × W × H)	mm	178 × 97 × 38	178 × 97 × 38	190 × 97 × 38
	inch	7.01 × 3.82 × 1.50	7.01 × 3.82 × 1.50	7.48 × 3.82 × 1.50
Unit Weight	kg	0.56	0.56	0.61
	lb	1.23	1.23	1.34
Cooling System		Convection		
MTBF ⁴⁾		> 700,000 hrs	> 700,000 hrs	> 700,000 hrs
ENVIRONMENT				
Operating Temperature ⁵⁾		-30°C to +70°C		
Storage Temperature		-30°C to +85°C		
Operating Humidity		5 to 95% RH (Non-Condensing)		
Operating Altitude		0 to 5,000 m (0 to 16,400 ft)		

Dimensions Reference

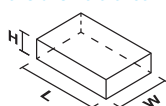

Notes

- 1) PARD is measured with an AC coupling mode, 5cm wires, and in parallel with 0.1µF ceramic capacitor & 47µF electrolytic capacitor.
- 2) All models fulfill the test conditions of this range. DC input safety approval can be obtained upon request.
- 3) At 25°C ambient temperature by vertical mounting orientation.
- 4) MTBF as per Telcordia SR-332 (Confidence level: 90%, I/P: 115Vac, O/P: 100% load) for vertical mounting orientation.
- 5) Refer power de-rating in the product datasheet.
- 6) All parameters are specified at 25°C ambient temperature unless otherwise indicated.

PMH - Low Profile



Features

- Household appliance approvals for pollution degree 3 to IEC/EN 60335-1, IEC/EN 61558-1 and IEC/EN 61558-2-16
- Universal AC input voltage range
- Full corrosion resistant aluminium casing
- Low profile design for 1U installation
- Low earth leakage current < 0.75mA
- No load input power consumption < 0.5W @ 230Vac
- Full power from -25°C to +50°C operation @ 5,000 m or 16,400 ft altitude
- Also available: IP20, Front Face and Harness connectors

Specifications

OUTPUT		PMH-12V100WCL□	PMH-12V100WCM□	PMH-24V100WCL□	PMH-24V100WCM□	PMH-24V150WCL□
Output Voltage		12V	12V	24V	24V	24V
Output Voltage Range		12-14V	11-12V	24-28V	22-24V	24-28V
Output Current		0-8.5A	0-4.5A	0-4.5A	0-3.8A	0-6.5A
Output Power		102W	54W	108W	91.2W	156W
PARD (20MHz) ¹⁾		< 120mVpp		< 150mVpp		< 200mVpp
Hold-up Time (100% Load)	115Vac	> 5ms	> 5ms	> 10ms	> 10ms	> 10ms
	230Vac	> 50ms	> 25ms	> 50ms	> 50ms	> 50ms
INPUT						
Phase Input		Single Phase				
Input Voltage Range		85-264Vac (DC input range 120-375Vdc) ²⁾				
Input Frequency		47-63Hz				
Input Current	115Vac	< 1.9A	< 1.5A	< 1.9A	< 1.9A	< 2.8A
	230Vac	< 1.2A	< 0.8A	< 1.2A	< 1.2A	< 1.6A
Efficiency ³⁾ at 100% Load	115Vac	> 83.0%	83.0%	> 86.0%	> 86.0%	> 87.0%
	230Vac	> 85.0%		> 88.0%	> 88.0%	> 89.0%
Max Inrush Current (Cold Start)	115Vac	< 30A	< 30A	< 25A	< 25A	< 40A
	230Vac	< 60A	< 60A	< 50A	< 50A	< 80A
Power Factor		Conform to EN 61000-3-2				
Leakage Current	240Vac	< 0.75mA	< 0.75mA	< 0.75mA	< 0.75mA	< 0.75mA
MECHANICAL						
Case Cover / Chassis		Aluminium				
Dimensions (L × W × H)	mm	129 × 97 × 30	129 × 97 × 30	129 × 97 × 30	129 × 97 × 30	159 × 97 × 30
	inch	5.08 × 3.82 × 1.18	5.08 × 3.82 × 1.18	5.08 × 3.82 × 1.18	5.08 × 3.82 × 1.18	6.26 × 3.82 × 1.18
Unit Weight	kg	0.31	0.31	0.31	0.31	0.41
	lb	0.68	0.68	0.68	0.68	0.90
Cooling System		Convection				
MTBF ⁴⁾		> 700,000 hrs		> 700,000 hrs	> 700,000 hrs	> 700,000 hrs
ENVIRONMENT						
Operating Temperature ⁵⁾		-30°C to +70°C				
Storage Temperature		-40°C to +85°C				
Operating Humidity		5 to 95% RH (Non-Condensing)				
Operating Altitude		0 to 5,000 m (0 to 16,400 ft)				

Dimensions Reference

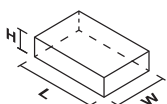

Notes

- 1) PARD is measured with an AC coupling mode, 5cm wires, and in parallel with 0.1µF ceramic capacitor & 47µF electrolytic capacitor.
- 2) All models fulfill the test conditions of this range. DC input safety approval can be obtained upon request.
- 3) At 25°C ambient temperature by vertical mounting orientation.
- 4) MTBF as per Telcordia SR-332 (Confidence level: 90%, I/P: 115Vac, O/P: 100% load) for vertical mounting orientation.
- 5) Refer power de-rating in the product datasheet.
- 6) All parameters are specified at 25°C ambient temperature unless otherwise indicated.



PMF

Features

- Universal AC input voltage range
- Built-in active PFC and automatic fan speed control
- Full corrosion resistant aluminium casing
- Conforms to harmonic current IEC/EN 61000-3-2, Class D
- Remote ON/OFF is available as an option
- Short Circuit / Overvoltage / Overcurrent / Over Temperature Protections

Specifications

OUTPUT		PMF-4V320WC□□	PMF-5V320WC□□	PMF-24V200WC□□	PMF-24V240WC□□	PMF-24V320WC□□
Output Voltage		4.2V	5V	24V	24V	24V
Output Voltage Range		3.78-4.62V	4.50-5.50V	21.6-26.4V	21.6-26.4V	21.6-26.4V
Output Current		55.0A	55.0A	8.4A	10.0A	13.3A
Output Power		231W	275W	201.6W	240W	320W
PARD (20MHz)		< 150mVpp				
Hold-up Time	115Vac	16ms typ.	16ms typ.	20ms typ.	20ms typ.	20ms typ.
	230Vac					
INPUT						
Phase Input		Single Phase				
Input Voltage Range		85-264Vac				
Input Frequency		47-63Hz				
Input Current	115Vac	5.0A typ.	5.0A typ.	3.5A typ.	3.6A typ.	5.0A typ.
	230Vac	2.5A typ.	2.5A typ.	1.7A typ.	1.8A typ.	2.5A typ.
Efficiency ¹⁾ at 100% Load	230Vac	76.5% typ.	78.5% typ.	87.0% typ.	87.0% typ.	87.0% typ.
Max Inrush Current (Cold Start)	115Vac	20A typ.	20A typ.	30A typ.	30A typ.	20A typ.
	230Vac	40A typ.	40A typ.	50A typ.	60A typ.	40A typ.
Power Factor	115Vac	0.97 typ.	0.98 typ.	0.98 typ.	0.99 typ.	0.98 typ.
	230Vac	0.94 typ.	0.95 typ.	0.95 typ.	0.95 typ.	0.95 typ.
Leakage Current	240Vac	< 1mA	< 1mA	< 0.5mA	< 0.5mA	< 1mA
MECHANICAL						
Case Cover / Chassis		Aluminium				
Dimensions (L × W × H)	mm	215 × 115 × 50	215 × 115 × 50	190 × 93 × 50	190 × 93 × 50	215 × 115 × 50
	inch	8.46 × 4.53 × 1.97	8.46 × 4.53 × 1.97	7.48 × 3.66 × 1.97	7.48 × 3.66 × 1.97	8.46 × 4.53 × 1.97
Unit Weight	kg	0.86	0.86	0.66	0.66	0.84
	lb	1.90	1.90	1.46	1.46	1.85
Cooling System		Forced Air (Built-in Fan)				
MTBF ²⁾		> 700,000 hrs	> 700,000 hrs	> 700,000 hrs	> 700,000 hrs	> 700,000 hrs
ENVIRONMENT						
Operating Temperature ³⁾		-10°C to +70°C				
Storage Temperature		-20°C to +85°C				
Operating Humidity		5 to 95% RH (Non-Condensing)				
Operating Altitude		0 to 5,000 m (0 to 16,400 ft)				

Dimensions Reference

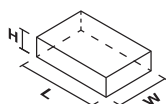

Notes

- 1) At 25°C ambient temperature by vertical mounting orientation.
- 2) MTBF as per Telcordia SR-332 (Confidence level: 90%, I/P: 100Vac, O/P: 100% load, Ta: 35°C). MTBF calculations do not include fan life time.
- 3) Refer power de-rating in the product datasheet.
- 4) All parameters are specified at 25°C ambient temperature unless otherwise indicated.



AR

PMR

Features

- Universal AC input voltage range
- Full corrosion resistant aluminium casing
- Built-in active PFC and conforms to harmonic current IEC/EN 61000-3-2, Class A and Class D
- Low profile design for 1U installation
- Built-in DC OK relay contact and redundancy operation (PMR-4V320WDBA and PMR-4V320WDCA)

Specifications

OUTPUT	PMR-4V320WC□A	PMR-4V320WDAA	PMR-4V320WDGA	PMR-4V320WDBA	PMR-4V320WDCA	
Output Voltage	4.2V	4.2V	4.2V	4.2V	4.2V	
Output Voltage Range	3.78-4.62V	3.78-4.62V	3.78-4.62V	3.99-4.51V (No potentiometer)	3.99-4.51V (No potentiometer)	
Output Current	60.0A	60.0A	60.0A	60.0A	60.0A	
Output Power	252W	252W	252W	252W	252W	
PARD (20MHz)	< 150mVpp					
Hold-up Time	8ms typ.	8ms typ.	8ms typ.	8ms typ.	8ms typ.	
INPUT						
Phase Input	Single Phase					
Input Voltage Range	88-264Vac					
Input Frequency	47-63Hz					
Input Current	115Vac	3.0A typ.	4.5A typ.	4.5A typ.	4.5A typ.	
	230Vac	1.5A typ.	2.5A typ.	2.5A typ.	2.5A typ.	
Efficiency ¹⁾ at 100% Load	115Vac	80.5% typ.	84.5% typ.	84.5% typ.	84.0% typ.	
	230Vac	83.5% typ.	86.5% typ.	86.5% typ.	86.0% typ.	
Max Inrush Current (Cold Start)	115Vac	20A typ.	20A typ.	20A typ.	20A typ.	
	230Vac	40A typ.	40A typ.	40A typ.	40A typ.	
Power Factor	115Vac	0.98 typ.	0.98 typ.	0.98 typ.	0.98 typ.	
	230Vac	0.95 typ.	0.95 typ.	0.95 typ.	0.95 typ.	
Leakage Current	240Vac	< 0.5mA	< 1mA	< 1mA	< 1mA	
MECHANICAL						
Case Cover / Chassis	Aluminium					
Dimensions (L × W × H)	mm	215 × 115 × 30	215 × 115 × 30	215 × 115 × 30	215 × 115 × 30	215 × 115 × 30
	inch	8.46 × 4.53 × 1.18	8.46 × 4.53 × 1.18	8.46 × 4.53 × 1.18	8.46 × 4.53 × 1.18	8.46 × 4.53 × 1.18
Unit Weight	kg	0.76	0.86	0.86	0.86	0.86
	lb	1.68	1.90	1.90	1.90	1.90
Cooling System	Forced Air (Built-in Fan)		Convection			
MTBF ²⁾	> 700,000 hrs	> 700,000 hrs	> 700,000 hrs	> 700,000 hrs	> 700,000 hrs	
ENVIRONMENT						
Operating Temperature ³⁾	-10°C to +70°C	-20°C to +70°C				
Storage Temperature	-40°C to +85°C					
Operating Humidity	5 to 95% RH (Non-Condensing)					
Operating Altitude	0 to 5,000 m (0 to 16,400 ft)					

Dimensions Reference

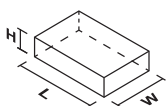

Notes

- 1) At 25°C ambient temperature by vertical mounting orientation.
- 2) MTBF as per Telcordia SR-332 (Confidence level: 90%, I/P: 100Vac, O/P: 100% load, Ta: 35°C). For PMR-4V320WC□A, MTBF calculation does not include fan life time.
- 3) Refer power de-rating in the product datasheet.
- 4) All parameters are specified at 25°C ambient temperature unless otherwise indicated.



PMR

Features

- Universal AC input voltage range
- Full corrosion resistant aluminium casing
- Built-in active PFC and conforms to harmonic current IEC/ EN 61000-3-2, Class A and Class D
- Low profile design for 1U installation
- Built-in DC OK relay contact and redundancy operation (PMR-5V320WDBA and PMR-5V320WDCA)

Specifications

OUTPUT	PMR-5V320WC□A	PMR-5V320WDAA	PMR-5V320WDGA	PMR-5V320WDBA	PMR-5V320WDCA
Output Voltage	5V	5V	5V	5V	5V
Output Voltage Range	4.50-5.50V	4.50-5.50V	4.50V-5.50V	4.75-5.25V (No potentiometer)	4.75-5.25V (No potentiometer)
Output Current	60.0A	60.0A	60.0A	60.0A	60.0A
Output Power	300W	300W	300W	300W	300W
PARD (20MHz)	< 150mVpp				
Hold-up Time	8ms typ.				
INPUT					
Phase Input	Single Phase				
Input Voltage Range	88-264Vac				
Input Frequency	47-63Hz				
Input Current	115Vac	4.5A typ.	5.0A typ.	5.0A typ.	5.0A typ.
	230Vac	2.5A typ.	2.5A typ.	2.5A typ.	2.5A typ.
Efficiency ¹⁾ at 100% Load	115Vac	81.0% typ.	86.0% typ.	86.0% typ.	85.0% typ.
	230Vac	84.0% typ.	88.0% typ.	88.0% typ.	87.0% typ.
Max Inrush Current (Cold Start)	115Vac	20A typ.	20A typ.	20A typ.	20A typ.
	230Vac	40A typ.	40A typ.	40A typ.	40A typ.
Power Factor	115Vac	0.98 typ.	0.98 typ.	0.98 typ.	0.98 typ.
	230Vac	0.95 typ.	0.95 typ.	0.95 typ.	0.95 typ.
Leakage Current	240Vac	< 0.5mA	< 1mA	< 1mA	< 1mA
MECHANICAL					
Case Cover / Chassis	Aluminium				
Dimensions (L × W × H)	mm	215 × 115 × 30	215 × 115 × 30	215 × 115 × 30	215 × 115 × 30
	inch	8.46 × 4.53 × 1.18	8.46 × 4.53 × 1.18	8.46 × 4.53 × 1.18	8.46 × 4.53 × 1.18
Unit Weight	kg	0.76	0.86	0.86	0.86
	lb	1.68	1.90	1.90	1.90
Cooling System	Forced Air (Built-in Fan)		Convection		
MTBF ²⁾	> 700,000 hrs	> 700,000 hrs	> 700,000 hrs	> 700,000 hrs	> 700,000 hrs
ENVIRONMENT					
Operating Temperature ³⁾	-10°C to +70°C	-20°C to +70°C			
Storage Temperature	-40°C to +85°C				
Operating Humidity	5 to 95% RH (Non-Condensing)				
Operating Altitude	0 to 5,000 m (0 to 16,400 ft)				

Dimensions Reference

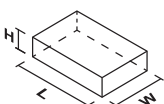

Notes

- 1) At 25°C ambient temperature by vertical mounting orientation.
- 2) MTBF as per Telcordia SR-332 (Confidence level: 90%, I/P: 100Vac, O/P: 100% load, Ta: 35°C). For PMR-5V320WC□A, MTBF calculation does not include fan life time.
- 3) Refer power de-rating in the product datasheet.
- 4) All parameters are specified at 25°C ambient temperature unless otherwise indicated.

PMU

Features



- AC input voltage range selectable by switch
- LED indicators for DC OK (Green) and Battery Reverse Polarity Connection (Red)
- Zero switch over time from loss of AC to battery operation
- Conforms to harmonic current IEC/EN 61000-3-2, Class A
- High MTBF > 700,000 hrs. per Telcordia SR-332
- Monitoring signals for AC OK, DC OK and Battery Low indication
- Overvoltage / Overcurrent / Over Temperature / Short Circuit Protections

Specifications

OUTPUT	PMU-13V155W□BA	PMU-13V155W□CA	PMU-27V155W□BA	PMU-27V155W□CA
Output Voltage	V1: 13.8V, B+: 13.3V	V1: 13.8V, B+: 13.3V	V1: 27.6V, B+: 27.1V	V1: 27.6V, B+: 27.1V
Output Voltage Range	12-14V	12-14V	24-28V	24-28V
Output Current	V1: 9.5A (0-11.0A) B+: 1.5A (0.5-1.5A)	V1: 9.5A (0-11.0A) B+: 1.5A (0.5-1.5A)	PMU-27V155WCBA V1: 4.0A (0-5.5A) B+: 1.5A (0.5-1.5A) PMU-27V155WLBA V1: 4.3A (0-5.5A) B+: 1.2A (0.50-1.2A)	PMU-27V155WCCA V1: 4.0A (0-5.5A) B+: 1.5A (0.5-1.5A) PMU-27V155WLCA V1: 4.3A (0-5.5A) B+: 1.2A (0.50-1.2A)
Output Power	151W	151W	151W	151W
PARD (20MHz)	< 150mVpp @ 0°C to -20°C, < 100mVpp @ > 0°C to 70°C			
Hold-up Time	20ms without Battery at B+			
INPUT				
Phase Input	Single Phase			
Input Voltage Range	90-132Vac, 180-264Vac (Selectable by Switch)			
Input Frequency	47-63Hz			
Input Current	115Vac < 2.5A 230Vac < 1.5A	< 2.5A < 1.5A	< 2.5A < 1.5A	< 2.5A < 1.5A
Efficiency ¹⁾ at 100% Load	115Vac > 85.0% 230Vac > 86.0%	> 85.0% > 86.0%	> 88.0% > 89.0%	> 88.0% > 89.0%
Max Inrush Current (Cold Start)	115Vac < 25A 230Vac < 25A	< 25A	< 25A	< 25A
Power Factor	Conform to EN 61000-3-2			
Leakage Current	264Vac	< 0.5mA		
MECHANICAL				
Case Cover / Chassis	SGCC / Aluminium			
Dimensions (L × W × H)	mm 178 × 97 × 38 inch 7.01 × 3.82 × 1.50	178 × 97 × 38 7.01 × 3.82 × 1.50	178 × 97 × 38 7.01 × 3.82 × 1.50	178 × 97 × 38 7.01 × 3.82 × 1.50
Unit Weight	kg 0.59 lb 1.30	0.60 1.32	0.59 1.30	0.60 1.32
Cooling System	Convection			
MTBF ²⁾	> 700,000 hrs	> 700,000 hrs	> 700,000 hrs	> 700,000 hrs
ENVIRONMENT				
Operating Temperature ³⁾	-20°C to +70°C			
Storage Temperature	-40°C to +85°C			
Operating Humidity	5 to 95% RH (Non-Condensing)			
Operating Altitude	0 to 5,000 m (0 to 16,400 ft)			

Dimensions Reference

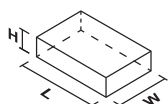

Notes

- 1) At 25°C ambient temperature by vertical mounting orientation.
- 2) MTBF as per Telcordia SR-332 (Confidence level: 90%, I/P: 115Vac, O/P: 100% load) for vertical mounting orientation.
- 3) Refer power de-rating in the product datasheet.
- 4) All parameters are specified at 25°C ambient temperature unless otherwise indicated.

INDUSTRIAL POWER SUPPLIES

| Open Frame Power Supply



AR

PJT

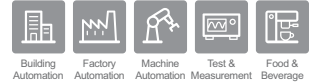

- Standard industrial footprint
- Low Leakage Current
- Convection cooled operating temperature range from -10°C to +70°C
- Multiple connector sources options (JWT, JST, Molex)



AR

PJ

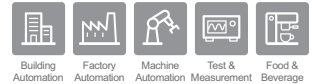

- Low Inrush Current / Low Leakage Current
- Conformal coating on PCBAs to protect against common dust and chemical pollutants
- Versatile configuration options: Open Frame, L Frame, Enclosed
- Remote ON/OFF option for selected models
- Long life capacitors



AR

PJB



- Power Boost of 200% for 10 seconds
- Low Inrush Current / Low Leakage Current
- Conformal coating on PCBAs to protect against common dust and chemical pollutants
- Versatile configuration options: Open Frame, L Frame, Enclosed
- Remote ON/OFF option for selected models



AR

PJH



- Household appliance approval to IEC/EN 60335-1, IEC/EN 61558-1 and IEC/EN 61558-2-16
- Available for Class I or Class II (double isolation) configuration with universal AC input voltage range
- Built-in active PFC, remote On/Off, remote sense, power good signal
- Cold start at -40°C



AR

PJU



- Zero switch over time from loss of AC to battery operation
- Protection against reverse polarity battery connection
- Built-in diagnostic monitoring for AC OK and Battery Low status
- Overvoltage / Overcurrent / Over Temperature / Short Circuit Protections
- Built-in over current and short circuit protection in Buffering (battery discharging) mode operation

INDUSTRIAL POWER SUPPLIES

| Open Frame Power Supply



AR

PJL



- Standard industrial footprint of 3" x 5"
- Low inrush current < 20A and up to 90.0% efficiency
- Low earth leakage current < 500 μ A
- Extreme low temperature operation at -40°C
- Lighting approval to UL 8750, IEC 61347-2-13 and other approvals to IEC/EN/UL 60950-1, IEC/EN/UL 62368-1



AR

MEP



- Safety approvals to medical and IT applications
- Compliant with IEC 60601-1-2 Ed. 4 requirements
- Low touch current (< 70 μ A Normal & < 210 μ A Single Fault)
- 2 x MOPP isolation

PAGE 103



AR

MEU



- 2 x MOPP isolation
- 5V/1A standby output and 12V/0.6A fan output
- Compliant with IEC 60601-1-2 Ed. 4 requirements

PAGE 104

Configuration Options

For the PJ series, PJB series and PJU series, metal chassis and case cover are available as options for different installation preferences.

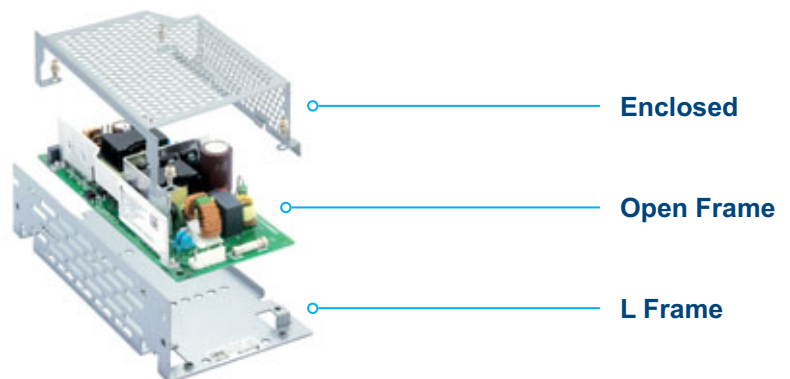

PJT

Features

- Universal AC input voltage range
- Small standard footprint
- Low Leakage Current < 0.1mA
- Conforms to harmonic current IEC/EN 61000-3-2, Class A
- High MTBF > 700,000 hrs. as per Telcordia SR-332
- Short Circuit / Overvoltage / Overcurrent / Over Temperature Protections



Specifications

OUTPUT		PJT-12V40WBA□	PJT-12V65WBA□	PJT-12V100WBA□	PJT-12V100WBB□
Output Voltage		12V	12V	12V	12V
Output Current		3.33A	5.0A	8.33A	6.67A (Convection) 8.33A (Forced Air)
Output Power		40W	60W	100W	80W (Convection) 100W (Forced Air)
PARD (20MHz)		< 120mVpp			
Hold-up Time	115Vac	18ms typ.	16ms typ.	20ms typ.	10ms typ.
	230Vac	90ms typ.	80ms typ.		
INPUT					
Phase Input		Single Phase			
Input Voltage Range		90-264Vac			
Input Frequency		47-63Hz			
Input Current	115Vac	0.85A typ.	1.50A typ.	1.50A typ.	2.50A typ.
Efficiency ¹⁾ at 100% Load	115Vac	85.0% typ.	86.0% typ.	86.5% typ.	86.0% typ.
	230Vac	86.0% typ.	86.5% typ.		88.0% typ.
Max Inrush Current (Cold Start)	115Vac	30A typ.	30A typ.	30A typ.	30A typ.
	230Vac	60A typ.	60A typ.	60A typ.	60A typ.
Power Factor		Conform to EN 61000-3-2			
Leakage Current	240Vac	< 0.1mA	< 0.1mA	< 0.1mA	< 0.1mA
MECHANICAL					
Case Cover / Chassis		-			
Dimensions (L × W × H)	mm	76.2 × 50.8 × 22.9	101.6 × 50.8 × 30	127 × 76.2 × 31	101.6 × 50.8 × 31.8
	inch	3.00 × 2.00 × 0.90	4.00 × 2.00 × 1.18	5.00 × 3.00 × 1.22	4.00 × 2.00 × 1.25
Unit Weight	kg	0.08	0.13	0.21	0.15
	lb	0.18	0.29	0.46	0.33
Cooling System		Convection			
MTBF ²⁾		> 700,000 hrs	> 700,000 hrs	> 700,000 hrs	> 700,000 hrs
ENVIRONMENT					
Operating Temperature ³⁾		-10°C to +70°C			
Storage Temperature		-40°C to +85°C			
Operating Humidity		10 to 95% RH (Non-Condensing)			
Operating Altitude		0 to 5,000 m (0 to 16,400 ft)			

Dimensions Reference

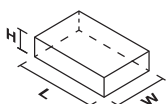

Notes

- 1) At 25°C ambient temperature.
- 2) MTBF as per Telcordia SR-332 (I/P: 115Vac, O/P: 100% load).
- 3) Refer power de-rating in the product datasheet.
- 4) All parameters are specified at 25°C ambient temperature unless otherwise indicated.

PJT

Features

- Universal AC input voltage range
- Small standard footprint
- Low Leakage Current < 0.1mA
- Conforms to harmonic current IEC/EN 61000-3-2, Class A
- High MTBF > 700,000 hrs. as per Telcordia SR-332
- Short Circuit / Overvoltage / Overcurrent / Over Temperature Protections



Specifications

OUTPUT		PJT-15V40WBA□	PJT-15V65WBA□	PJT-15V100WBA□	PJT-15V100WBB□
Output Voltage		15V	15V	15V	15V
Output Current		2.67A	4.2A	6.67A	5.33A (Convection) 6.67A (Forced Air)
Output Power		40W	63W	100W	80W (Convection) 100W (Forced Air)
PARD (20MHz)		< 150mVpp			
Hold-up Time	115Vac	18ms typ.	16ms typ.	20ms typ.	10ms typ.
	230Vac	90ms typ.	80ms typ.		
INPUT					
Phase Input		Single Phase			
Input Voltage Range		90-264Vac			
Input Frequency		47-63Hz			
Input Current	115Vac	0.85A typ.	1.50A typ.	1.50A typ.	2.50A typ.
Efficiency ¹⁾ at 100% Load	115Vac	86.0% typ.	87.0% typ.	87.5% typ.	87.0% typ.
	230Vac	87.0% typ.	88.5% typ.		89.0% typ.
Max Inrush Current (Cold Start)	115Vac	30A typ.	30A typ.	30A typ.	30A typ.
	230Vac	60A typ.	60A typ.		
Power Factor		Conform to EN 61000-3-2			
Leakage Current	240Vac	< 0.1mA			
MECHANICAL					
Case Cover / Chassis		-			
Dimensions (L × W × H)	mm	76.2 × 50.8 × 22.9	101.6 × 50.8 × 30	127 × 76.2 × 31	101.6 × 50.8 × 31.8
	inch	3.00 × 2.00 × 0.90	4.00 × 2.00 × 1.18	5.00 × 3.00 × 1.22	4.00 × 2.00 × 1.25
Unit Weight	kg	0.08	0.13	0.21	0.15
	lb	0.18	0.29	0.46	0.33
Cooling System		Convection			Convection / Forced Air
MTBF ²⁾		> 700,000 hrs	> 700,000 hrs	> 700,000 hrs	> 700,000 hrs
ENVIRONMENT					
Operating Temperature ³⁾		-10°C to +70°C			
Storage Temperature		-40°C to +85°C			
Operating Humidity		10 to 95% RH (Non-Condensing)			
Operating Altitude		0 to 5,000 m (0 to 16,400 ft)			

Dimensions Reference

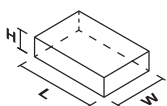

Notes

- 1) At 25°C ambient temperature.
- 2) MTBF as per Telcordia SR-332 (I/P: 115Vac, O/P: 100% load).
- 3) Refer power de-rating in the product datasheet.
- 4) All parameters are specified at 25°C ambient temperature unless otherwise indicated.

PJT

Features

- Universal AC input voltage range
- Small standard footprint
- Low Leakage Current < 0.1mA
- Conforms to harmonic current IEC/EN 61000-3-2, Class A
- High MTBF > 700,000 hrs. as per Telcordia SR-332
- Short Circuit / Overvoltage / Overcurrent / Over Temperature Protections



Specifications

OUTPUT		PJT-18V40WBA□	PJT-18V65WBA□	PJT-18V100WBA□	PJT-18V100WBB□
Output Voltage		18V	18V	18V	18V
Output Current		2.22A	3.61A	5.55A	4.44A (Convection) 5.55A (Forced Air)
Output Power		40W	65W	100W	80W (Convection) 100W (Forced Air)
PARD (20MHz)		< 180mVpp			
Hold-up Time	115Vac	18ms typ.	16ms typ.	20ms typ.	10ms typ.
	230Vac	90ms typ.	80ms typ.		
INPUT					
Phase Input		Single Phase			
Input Voltage Range		90-264Vac			
Input Frequency		47-63Hz			
Input Current	115Vac	0.85A typ.	1.50A typ.	1.50A typ.	2.50A typ.
Efficiency ¹⁾ at 100% Load	115Vac	86.0% typ.	87.0% typ.	87.5% typ.	87.0% typ.
	230Vac		88.0% typ.		89.0% typ.
Max Inrush Current (Cold Start)	115Vac	30A typ.	30A typ.	30A typ.	30A typ.
	230Vac	60A typ.	60A typ.	60A typ.	60A typ.
Power Factor		Conform to EN 61000-3-2			
Leakage Current	240Vac	< 0.1mA			
MECHANICAL					
Case Cover / Chassis		-			
Dimensions (L × W × H)	mm	76.2 × 50.8 × 22.9	101.6 × 50.8 × 30	127 × 76.2 × 31	101.6 × 50.8 × 31.8
	inch	3.00" × 2.00" × 0.90	4.00 × 2.00 × 1.18	5.00 × 3.00 × 1.22	4.00 × 2.00 × 1.25
Unit Weight	kg	0.08	0.13	0.21	0.15
	lb	0.18	0.29	0.46	0.33
Cooling System		Convection			
MTBF ²⁾		> 700,000 hrs	> 700,000 hrs	> 700,000 hrs	> 700,000 hrs
ENVIRONMENT					
Operating Temperature ³⁾		-10°C to +70°C			
Storage Temperature		-40°C to +85°C			
Operating Humidity		10 to 95% RH (Non-Condensing)			
Operating Altitude		0 to 5,000 m (0 to 16,400 ft)			

Dimensions Reference

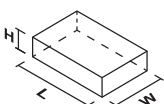

Notes

- 1) At 25°C ambient temperature.
- 2) MTBF as per Telcordia SR-332 (I/P: 115Vac, O/P: 100% load).
- 3) Refer power de-rating in the product datasheet.
- 4) All parameters are specified at 25°C ambient temperature unless otherwise indicated.

PJT

Features

- Universal AC input voltage range
- Small standard footprint
- Low Leakage Current
- Conforms to harmonic current IEC/EN 61000-3-2, Class A
- High MTBF > 700,000 hrs. as per Telcordia SR-332
- Short Circuit / Overvoltage / Overcurrent / Over Temperature Protections

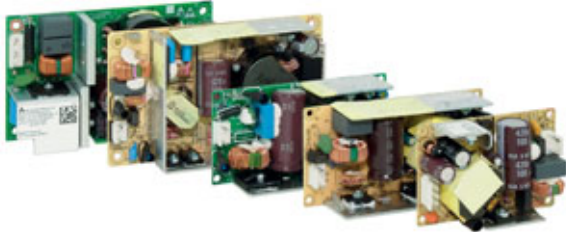

Specifications

OUTPUT		PJT-24V40WBA□	PJT-24V65WBA□	PJT-24V100WBA□	PJT-24V100WBB□	PJT-27V150WBNA
Output Voltage		24V	24V	24V	24V	V1: 27V, V _{SB} : 12V
Output Current		1.66A	2.71A	4.17A	3.33A (Convection) 4.17A (Forced Air)	V1: 5.55A V _{SB} : 0.5A
Output Power		40W	65W	100W	80W (Convection) 100W (Forced Air)	V1: 150W V _{SB} : 6W
PARD (20MHz)		< 240mVpp				V1: < 150mVpp, V _{SB} : < 75mVpp
Hold-up Time	115Vac	18ms typ.	16ms typ.	20ms typ.	10ms typ.	> 40ms
	230Vac	90ms typ.	80ms typ.			
INPUT						
Phase Input		Single Phase				
Input Voltage Range		90-264Vac				85-264Vac
Input Frequency		47-63Hz				
Input Current	115Vac	0.85A typ.	1.50A typ.	1.50A typ.	2.50A typ.	< 1.80A
	230Vac	-	-	-	-	< 0.90A
Efficiency ¹⁾ at 100% Load	115Vac	86.0% typ.	87.0% typ.	88.0% typ.	88.0% typ.	> 88.5%
	230Vac	87.0% typ.				> 89.5%
Max Inrush Current (Cold Start)	115Vac	30A typ.	30A typ.	30A typ.	30A typ.	< 50A
	230Vac	60A typ.	60A typ.	60A typ.	60A typ.	< 100A
Power Factor	115Vac	Conform to EN 61000-3-2				> 0.99
	230Vac					> 0.93
Leakage Current	240Vac	< 0.1mA	< 0.1mA	< 0.1mA	< 0.1mA	-
	264Vac	-	-	-	-	< 0.25mA
MECHANICAL						
Case Cover / Chassis		-				
Dimensions (L × W × H)	mm	76.2 × 50.8 × 22.9	101.6 × 50.8 × 30	127 × 76.2 × 31	101.6 × 50.8 × 31.8	127 × 76.2 × 36.5
	inch	3.00 × 2.00 × 0.90	4.00 × 2.00 × 1.18	5.00 × 3.00 × 1.22	4.00 × 2.00 × 1.25	5.00 × 3.00 × 1.44
Unit Weight	kg	0.08	0.13	0.21	0.15	0.37
	lb	0.18	0.29	0.46	0.33	0.82
Cooling System		Convection			Convection / Forced Air	Convection
MTBF ²⁾		> 700,000 hrs	> 700,000 hrs	> 700,000 hrs	> 700,000 hrs	> 700,000 hrs
ENVIRONMENT						
Operating Temperature ³⁾		-10°C to +70°C				
Storage Temperature		-40°C to +85°C				
Operating Humidity		10 to 95% RH (Non-Condensing); PJT-27V150WBNA: 5 to 95% RH (Non-Condensing)				
Operating Altitude		0 to 5,000 m (0 to 16,400 ft)				

Dimensions Reference

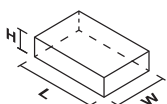

Notes

- 1) At 25°C ambient temperature.
- 2) MTBF as per Telcordia SR-332 (I/P: 115Vac, O/P: 100% load).
- 3) Refer power de-rating in the product datasheet.
- 4) All parameters are specified at 25°C ambient temperature unless otherwise indicated.

PJ

Features

- Universal AC input voltage range
- High PF > 0.97 (for 50W and above)
- Low Inrush Current / Low Leakage Current
- Conforms to harmonic current IEC/EN 61000-3-2, Class A; Class A and Class D for 50W and above
- Conformal coating on PCBAs to protect against common dust and chemical pollutants
- Versatile configuration options: Open Frame, L Frame, Enclosed



Specifications

OUTPUT		PJ-12V15W□□A	PJ-12V30W□□A	PJ-12V50W□□A	PJ-12V100W□□A	PJ-12V150W□□A	
Output Voltage		12V	12V	12V	12V	12V	
Output Voltage Range		10.8-13.2V	10.8-13.2V	10.8-13.2V	10.8-13.2V	10.8-13.2V	
Output Current		1.3A	2.5A	4.3A	8.5A	12.5A	
Output Power		15.6W	30W	51.6W	102W	150W	
PARD (20MHz)		< 150mVpp					
Hold-up Time	100Vac	20ms typ.	20ms typ.	20ms typ.	20ms typ.	20ms typ.	
INPUT							
Phase Input		Single Phase					
Input Voltage Range		85-264Vac					
Input Frequency		47-63Hz					
Input Current	100Vac	0.35A typ.	0.65A typ.	0.65A typ.	1.30A typ.	1.90A typ.	
	200Vac	0.20A typ.	0.35A typ.	0.35A typ.	0.65A typ.	0.95A typ.	
Efficiency ¹⁾ at 100% Load	100Vac	81.0% typ.	83.0% typ.	83.0% typ.	85.0% typ.	88.0% typ.	
	200Vac	82.5% typ.	85.0% typ.	85.0% typ.	87.5% typ.	91.0% typ.	
Max Inrush Current (Cold Start)	100Vac	15A typ.	15A typ.	15A typ.	15A typ.	15A typ.	
	200Vac	30A typ.	30A typ.	30A typ.	30A typ.	30A typ.	
Power Factor	100Vac	Conform to EN 61000-3-2			0.98 typ.	0.99 typ.	0.99 typ.
	200Vac				0.97 typ.	0.98 typ.	0.97 typ.
Leakage Current	100Vac	< 0.1mA	< 0.1mA	< 0.1mA	< 0.2mA	< 0.2mA	
	240Vac	< 0.2mA	< 0.2mA	< 0.2mA	< 0.4mA	< 0.4mA	
MECHANICAL							
Case Cover / Chassis		SGCC					
Dimensions ²⁾ (L × W × H)	mm	87.5 × 50 × 22	105 × 50 × 25.6	132 × 50 × 26.6	155 × 62 × 33.5	160 × 75 × 37	
	inch	3.44 × 1.97 × 0.87	4.13 × 1.97 × 1.01	5.20 × 1.97 × 1.05	6.10 × 2.44 × 1.32	6.30 × 2.95 × 1.46	
Unit Weight ²⁾	kg	0.06	0.11	0.16	0.26	0.30	
	kg	0.13	0.24	0.35	0.57	0.66	
Cooling System		Convection					
MTBF ³⁾		> 200,000 hrs	> 200,000 hrs	> 200,000 hrs	> 200,000 hrs	> 200,000 hrs	
ENVIRONMENT							
Operating Temperature ⁴⁾		-10°C to +70°C					
Storage Temperature		-25°C to +75°C					
Operating Humidity		5 to 95% RH (Non-Condensing)					
Operating Altitude		0 to 5,000 m (0 to 16,400 ft)					

Dimensions Reference

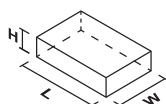

Notes

- 1) At 25°C ambient temperature.
- 2) Open Frame (without chassis and cover).
- 3) MTBF as per JEITA RCR-9102B.
- 4) Refer power de-rating in the product datasheet.
- 5) All parameters are specified at 25°C ambient temperature unless otherwise indicated.

PJ

Features

- Universal AC input voltage range
- High PF > 0.97 (for 50W and above)
- Low Inrush Current / Low Leakage Current
- Conforms to harmonic current IEC/EN 61000-3-2, Class A; Class A and Class D for 50W and above
- Conformal coating on PCBAs to protect against common dust and chemical pollutants
- Versatile configuration options: Open Frame, L Frame, Enclosed
- Remote ON/OFF option for selected models
- Long life capacitors



Specifications

OUTPUT		PJ-24V30W□□A	PJ-24V50W□□A	PJ-24V100W□□A	PJ-24V150W□□A
Output Voltage		24V	24V	24V	24V
Output Voltage Range		21.6-26.4V	21.6-26.4V	21.6-26.4V	21.6-26.4V
Output Current		1.3A	2.1A	4.3A	6.3A
Output Power		31.2W	50.4W	103.2W	150W
PARD (20MHz)		< 150mVpp			
Hold-up Time	100Vac	20ms typ.	20ms typ.	20ms typ.	20ms typ.
INPUT					
Phase Input		Single Phase			
Input Voltage Range		85-264Vac			
Input Frequency		47-63Hz			
Input Current	100Vac	0.65A typ.	0.65A typ.	1.30A typ.	1.90A typ.
	200Vac	0.35A typ.	0.35A typ.	0.65A typ.	0.95A typ.
Efficiency ¹⁾ at 100% Load	100Vac	85.0% typ.	84.5% typ.	86.0% typ.	88.0% typ.
	200Vac	86.0% typ.	87.0% typ.	89.0% typ.	91.0% typ.
Max Inrush Current (Cold Start)	100Vac	15A typ.	15A typ.	15A typ.	15A typ.
	200Vac	30A typ.	30A typ.	30A typ.	30A typ.
Power Factor	100Vac	Conform to EN 61000-3-2		0.98 typ.	0.99 typ.
	200Vac			0.97 typ.	0.97 typ.
Leakage Current	100Vac	< 0.1mA	< 0.1mA	< 0.2mA	< 0.2mA
	240Vac	< 0.2mA	< 0.2mA	< 0.4mA	< 0.4mA
MECHANICAL					
Case Cover / Chassis		SGCC			
Dimensions ²⁾ (L × W × H)	mm	105 × 50 × 25.6	132 × 50 × 26.6	155 × 62 × 33.5	160 × 75 × 37
	inch	4.13 × 1.97 × 1.01	5.20 × 1.97 × 1.05	6.10 × 2.44 × 1.32	6.30 × 2.95 × 1.46
Unit Weight ²⁾	kg	0.11	0.16	0.26	0.29
	lb	0.24	0.35	0.57	0.64
Cooling System		Convection			
MTBF ³⁾		> 200,000 hrs	> 200,000 hrs	> 200,000 hrs	> 200,000 hrs
ENVIRONMENT					
Operating Temperature ⁴⁾		-10°C to +70°C			
Storage Temperature		-25°C to +75°C			
Operating Humidity		5 to 95% RH (Non-Condensing)			
Operating Altitude		0 to 5,000 m (0 to 16,400 ft)			

Dimensions Reference

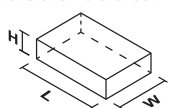

Notes

- 1) At 25°C ambient temperature.
- 2) Open Frame (without chassis and cover).
- 3) MTBF as per JEITA RCR-9102B.
- 4) Refer power de-rating in the product datasheet.
- 5) All parameters are specified at 25°C ambient temperature unless otherwise indicated.

PJ

Features

- Universal AC input voltage range
- High PF > 0.97 (for 50W)
- Low Inrush Current / Low Leakage Current
- Conforms to harmonic current IEC/EN 61000-3-2, Class A; Class A and Class D for 50W
- Conformal coating on PCBAs to protect against common dust and chemical pollutants
- Versatile configuration options: Open Frame, L Frame, Enclosed
- Long life capacitors



Specifications

OUTPUT		PJ-5V15W□□A	PJ-48V50W□□A
Output Voltage		5V	48V
Output Voltage Range		4.50-5.50V	43.2-52.8V
Output Current		3.0A	1.1A
Output Power		15W	52.8W
PARD (20MHz)		< 120mVpp	< 250mVpp
Hold-up Time	100Vac	20ms typ.	20ms typ.
INPUT			
Phase Input		Single Phase	
Input Voltage Range		85-264Vac	
Input Frequency		47-63Hz	
Input Current	100Vac	0.35A typ.	0.65A typ.
	200Vac	0.20A typ.	0.35A typ.
Efficiency ¹⁾ at 100% Load	100Vac	78.0% typ.	83.0% typ.
	200Vac	79.5% typ.	85.0% typ.
Max Inrush Current (Cold Start)	100Vac	15A typ.	15A typ.
	200Vac	30A typ.	30A typ.
Power Factor	100Vac	Conform to EN 61000-3-2	0.98 typ.
	200Vac		0.97 typ.
Leakage Current	100Vac	< 0.1mA	< 0.1mA
	240Vac	< 0.2mA	< 0.2mA
MECHANICAL			
Case Cover / Chassis		SGCC	
Dimensions ²⁾ (L × W × H)	mm	87.5 × 50 × 22	132 × 50 × 26.6
	inch	3.44 × 1.97 × 0.87	5.20 × 1.97 × 1.05
Unit Weight ²⁾	kg	0.06	0.16
	lb	0.13	0.35
Cooling System		Convection	
MTBF ³⁾		> 200,000 hrs	> 200,000 hrs
ENVIRONMENT			
Operating Temperature ⁴⁾		-10°C to +70°C	
Storage Temperature		-25°C to +75°C	
Operating Humidity		5 to 95% RH (Non-Condensing)	
Operating Altitude		0 to 5,000 m (0 tp 16,400 ft)	

Dimensions Reference

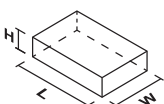

Notes

- 1) At 25°C ambient temperature.
- 2) Open Frame (without chassis and cover).
- 3) MTBF as per JEITA RCR-9102B.
- 4) Refer power de-rating in the product datasheet.
- 5) All parameters are specified at 25°C ambient temperature unless otherwise indicated.

PJB

Features

- Universal AC input voltage range
- Power Boost of 200% for 10 seconds
- High PF > 0.97
- Low Inrush Current / Low Leakage Current
- Conforms to harmonic current IEC/EN 61000-3-2, Class A
- Versatile configuration options: Open Frame, L Frame, Enclosed
- Remote ON/OFF option for selected models



Specifications

OUTPUT		PJB-24V100W□□□A	PJB-24V150W□□□A	PJB-24V240W□□□A	NEW PJB-24V300W□□□A
Output Voltage		24V	24V	24V	24V
Output Voltage Range		21.6-26.4V	21.6-26.4V	21.6-26.4V	21.6-26.4V
Output Current		4.3A (8.6A for 10s)	6.3A (12.6A for 10s)	10.0A (20.0A for 10s)	12.5A (22.5A for 10s)
Output Power		103.2W (206.4W for 10s)	151.2W (302.4W for 10s)	240W (480W for 10s)	300W (600W for 10s)
PARD (20MHz)		< 150mVpp			
Hold-up Time	100Vac	20ms typ.	20ms typ.	20ms typ.	20ms typ.
INPUT					
Phase Input		Single Phase			
Input Voltage Range		85-264Vac			
Input Frequency		47-63Hz			
Input Current	100Vac	1.30A typ.	1.90A typ.	2.80A typ.	4.10A typ.
	200Vac	0.65A typ.	0.95A typ.	1.50A typ.	2.00A typ.
Efficiency ¹⁾ at 100% Load	100Vac	86.5% typ.	88.0% typ.	91.0% typ.	91.0% typ.
	200Vac	89.0% typ.	90.5% typ.	92.5% typ.	93.5% typ.
Max Inrush Current (Cold Start)	100Vac	15A typ.	15A typ.	15A typ.	15A typ.
	200Vac	30A typ.	30A typ.	30A typ.	30A typ.
Power Factor	100Vac	0.98 typ.	0.98 typ.	0.98 typ.	0.99 typ.
	200Vac	0.97 typ.	0.95 typ.	0.97 typ.	0.95 typ.
Leakage Current	100Vac	< 0.2mA	< 0.2mA	< 0.2mA	< 0.2mA
	240Vac	< 0.4mA	< 0.4mA	< 0.4mA	< 0.4mA
MECHANICAL					
Case Cover / Chassis		SGCC			
Dimensions ²⁾ (L × W × H)	mm	155 × 62 × 33.5	160 × 75 × 37	180 × 84 × 42	222 × 95 × 53.6
	inch	6.10 × 2.44 × 1.32	6.30 × 2.95 × 1.46	7.09 × 3.31 × 1.65	8.74 × 3.74 × 2.11
Unit Weight ²⁾	kg	0.26	0.31	0.44	0.64
	lb	0.57	0.68	0.97	1.41
Cooling System		Convection			
MTBF ³⁾		> 200,000 hrs	> 200,000 hrs	> 200,000 hrs	> 200,000 hrs
ENVIRONMENT					
Operating Temperature ⁴⁾		-10°C to +70°C			
Storage Temperature		-25°C to +75°C			
Operating Humidity		5 to 95% RH (Non-Condensing)			
Operating Altitude		0 to 5,000 m (0 to 16,400 ft)		ITE Application: 0 to 5,000 m (0 to 16,400 ft) PSE Class 1: 0 to 2,000 m (0 to 6,560 ft)	0 to 5,000 m (0 to 16,400 ft)

Dimensions Reference

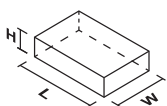

Notes

- 1) At 25°C ambient temperature.
- 2) Open Frame (without chassis and cover).
- 3) MTBF as per JEITA RCR-9102B.
- 4) Refer power de-rating in the product datasheet.
- 5) All parameters are specified at 25°C ambient temperature unless otherwise indicated.

PJH

Features



- Household appliance approval for pollution degree 3 to IEC/EN 60335-1, IEC/EN 61558-1 and IEC/EN 61558-2-16
- Available for Class I or Class II (double isolation) configuration with universal AC input voltage range
- 300W with fan cooled and up to 240W convection cooled
- Standard industrial footprint of 3" x 5"
- Built-in active PFC, remote ON/OFF, remote sense, power good signal
- No load input power consumption < 0.5W and low earth leakage current < 0.75mA
- Extreme low temperature cold start at -40°C

Specifications

		NEW	NEW	NEW	NEW
OUTPUT		PJH-24V300WBB□	PJH-24V300WBC□	PJH-36V300WBB□	PJH-36V300WBC□
Output Voltage		V1: 24V, V _{SB} : 5V	V1: 24V, V _{SB} : 12V	V1: 36V, V _{SB} : 5V	V1: 36V, V _{SB} : 12V
Output Voltage Range		V1: 22.8-25.2V, V _{SB} : Fixed	V1: 22.8-25.2V, V _{SB} : Fixed	V1: 34.2-37.8V, V _{SB} : Fixed	V1: 34.2-37.8V, V _{SB} : Fixed
Output Current		V1: 0-12.5A V _{SB} : 0-1.2A	V1: 0-12.5A V _{SB} : 0-0.5A	V1: 0-8.3A V _{SB} : 0-1.2A	V1: 0-8.3A V _{SB} : 0-0.5A
Output Power		240W (Convection) 300W (with 10CFM Forced Air)	240W (Convection) 300W (with 10CFM Forced Air)	240W (Convection) 300W (with 10CFM Forced Air)	240W (Convection) 300W (with 10CFM Forced Air)
PARD (20MHz)		V1: < 240mVpp, V _{SB} : < 120mVpp		V1: < 360mVpp, V _{SB} : < 120mVpp	
Hold-up Time	115Vac 230Vac	> 10ms	> 10ms	> 10ms	> 10ms
INPUT					
Phase Input		Single Phase			
Input Voltage Range		90-264Vac			
Input Frequency		47-63Hz			
Input Current	115Vac 230Vac	< 4.0A < 2.0A	< 4.0A < 2.0A	< 4.0A < 2.0A	< 4.0A < 2.0A
Efficiency ¹⁾ at 100% Load	115Vac 230Vac	> 93.0% > 94.0%	> 93.0% > 94.0%	> 93.0% > 94.0%	> 93.0% > 94.0%
Max Inrush Current (Cold Start)	115Vac 230Vac	< 20A < 40A	< 20A < 40A	< 20A < 40A	< 20A < 40A
Power Factor	115Vac 230Vac	> 0.95	> 0.95	> 0.95	> 0.95
Leakage Current	240Vac	< 0.75mA	< 0.75mA	< 0.75mA	< 0.75mA
MECHANICAL					
Case Cover / Chassis		-			
Dimensions (L x W x H)	mm inch	127 x 76.2 x 35.8 5.00 x 3.00 x 1.41	127 x 76.2 x 35.8 5.00 x 3.00 x 1.41	127 x 76.2 x 35.8 5.00 x 3.00 x 1.41	127 x 76.2 x 35.8 5.00 x 3.00 x 1.41
Unit Weight	kg lb	0.45 0.99	0.45 0.99	0.45 0.99	0.45 0.99
Cooling System		Convection / Forced Air			
MTBF ²⁾		> 700,000 hrs			
ENVIRONMENT					
Operating Temperature ³⁾		-25°C to +70°C			
Storage Temperature		-40°C to +85°C			
Operating Humidity		5 to 95% RH (Non-Condensing)			
Operating Altitude		PD3: 0 to 5,000 m (0 to 16,400 ft) PD2: 0 to 3,000 m (0 to 9,840 ft)			

Dimensions Reference

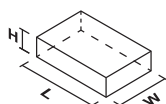

Notes

- 1) At 25°C ambient temperature.
- 2) MTBF as per Telcordia SR-332 (I/P: 115Vac, O/P: 100% load).
- 3) Refer power de-rating in the product datasheet.
- 4) All parameters are specified at 25°C ambient temperature unless otherwise indicated.

PJU

Features

- Universal AC input voltage range
- Zero switch over time from loss of AC to battery operation
- Protection against reverse polarity battery connection
- Built-in diagnostic monitoring for AC OK and Battery Low status
- Overvoltage / Overcurrent / Over Temperature / Short Circuit Protections
- Built-in over current and short circuit protection in Buffering (battery discharging) mode operation



Specifications

OUTPUT		PJU-13V60W□A□	PJU-13V60W□B□	PJU-27V60W□A□	PJU-27V60W□B□
Output Voltage		V1: 13.8V, B+: 13.6V	V1: 13.8V, B+: 13.6V	V1: 27.6V, B+: 27.4V	V1: 27.6V, B+: 27.4V
Output Voltage Range		V1: 13.52-14.07V	V1: 13.52-14.07V	V1: 27.04-28.00V	V1: 27.04-28.00V
Output Current		V1: 3.9A, B+: 0.4A	V1: 3.9A, B+: 0.4A	V1: 1.75A, B+: 0.4A	V1: 1.75A, B+: 0.4A
Output Power		60W	60W	60W	60W
PARD (20MHz)		< 100mVpp			
Hold-up Time (100% Load)	115Vac	> 10ms	> 10ms	> 10ms	> 10ms
INPUT					
Phase Input		Single Phase			
Input Voltage Range		90-264Vac			
Input Frequency		47-63Hz			
Input Current	115Vac	< 1.2A	< 1.2A	< 1.2A	< 1.2A
	230Vac	< 0.8A	< 0.8A	< 0.8A	< 0.8A
Efficiency ¹⁾ at 100% Load	115Vac	> 85.0%	> 85.0%	> 88.0%	> 88.0%
	230Vac	> 86.0%	> 86.0%	> 89.0%	> 89.0%
Max Inrush Current (Cold Start)	115Vac	< 60A	< 60A	< 60A	< 60A
	230Vac	< 60A	< 60A	< 60A	< 60A
Power Factor		Conform to EN 61000-3-2			
Leakage Current	240Vac	< 1mA	< 1mA	< 1mA	< 1mA
MECHANICAL					
Case Cover / Chassis		SECC Steel			
Dimensions ²⁾ (L × W × H)	mm	101.6 × 50.8 × 30.6	101.6 × 50.8 × 30.6	101.6 × 50.8 × 30.6	101.6 × 50.8 × 30.6
	inch	4.00 × 2.00 × 1.20	4.00 × 2.00 × 1.20	4.00 × 2.00 × 1.20	4.00 × 2.00 × 1.20
Unit Weight ²⁾	kg	0.12	0.12	0.12	0.12
	lb	0.26	0.26	0.26	0.26
Cooling System		Convection			
MTBF ³⁾		> 350,000 hrs	> 350,000 hrs	> 350,000 hrs	> 350,000 hrs
ENVIRONMENT					
Operating Temperature ⁴⁾		-20°C to +70°C			
Storage Temperature		-40°C to +85°C			
Operating Humidity		5 to 95% RH (Non-Condensing)			
Operating Altitude		0 to 5,000 m (0 to 16,400 ft)			

Dimensions Reference

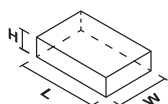

Notes

- 1) At 25°C ambient temperature.
- 2) Open frame (without chassis and cover).
- 3) MTBF as per Telcordia SR-332 (I/P: 115Vac & 230Vac, O/P: 100% load).
- 4) Refer power de-rating in the product datasheet.
- 5) All parameters are specified at 25°C ambient temperature unless otherwise indicated.

PJL

Features

- Universal AC input voltage range
- Standard industrial footprint of 3" x 5"
- Low inrush current < 20A and up to 90.0% efficiency
- Low earth leakage current < 500µA
- Extreme low temperature operation at -40°C
- Lighting approval to UL 8750, IEC 61347-2-13 and other approvals to IEC/EN/UL 60950-1, IEC/EN/UL 62368-1



Specifications

OUTPUT		PJL-48V200WBAA	PJL-48V400WBAA
Output Voltage		48V	48V
Output Voltage Range		48-50Vdc	48-50Vdc
Output Current		0-4.17A	0-8.33A
Output Power		150W (Convection) 200W (with 400 LFM Forced Air)	200W (Convection) 400W (with 400 LFM Forced Air)
PARD (20MHz) ¹⁾		< 480mVpp	< 680mVpp
Hold-up Time (100% Load)	115Vac	> 5ms	> 5ms
	230Vac		
INPUT			
Phase Input		Single Phase	
Input Voltage Range		85-305Vac	
Input Frequency		47-63Hz	
Input Current	115Vac	< 2.20A	< 4.74A
Efficiency at 100% Load ²⁾	115Vac	> 85.0%	> 85.0%
	230Vac	> 90.0%	> 90.0%
Max Inrush Current (Cold Start)	230Vac	< 20A	< 20A
Power Factor	115Vac	> 0.95	> 0.95
	230Vac		
Leakage Current		< 500µA	< 500µA
MECHANICAL			
Case Cover / Chassis		-	
Dimensions (L x W x H)	mm	127.6 × 76.2 × 34.8	127 × 76.6 × 39.3
	inch	5.02 × 3.00 × 1.38	5.00 × 3.02 × 1.55
Unit Weight	kg	0.42	0.44
	lb	0.93	0.97
Cooling System		Convection / Forced Air	
MTBF ³⁾		> 500,000 hrs	
ENVIRONMENT			
Operating Temperature		-40°C to +70°C	-40°C to +80°C
Storage Temperature		-40°C to +85°C	
Operating Humidity		5 to 95% RH (Non-Condensing)	
Operating Altitude		0 to 5,000m (0 to 16,400 ft)	

Dimensions Reference

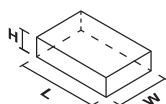

Notes

- 1) PARD is measured with an AC coupling mode, 5cm wires, and in parallel with 0.1µF ceramic capacitor & 47µF electrolytic capacitor.
- 2) At 25°C ambient temperature by vertical mounting orientation.
- 3) MTBF as per Telcordia SR-332 (Confidence level: 90%, I/P: 115Vac, O/P: 100% load).
- 4) Refer power de-rating in the product datasheet.
- 4) All parameters are specified at 25°C ambient temperature unless otherwise indicated.

INDUSTRIAL POWER SUPPLIES

| DIN Rail Modules



AR

CliQ^{II}

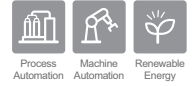

Redundancy Modules

- Wide input and output range of 22-60Vdc
- Very wide operating temperature from -40°C to +80°C
- Built-in 2 channel DC OK signal and alarm relay contact
- Support N+1 Redundancy connection
- Hazardous Locations approval to ATEX and Class I, Div 2



AR

CliQ^{II}

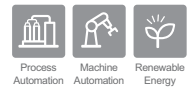

Buffer Modules

- Minimum buffering time of:
 - 250ms @ 24V/20A for DRB-24V020AB□
 - 200ms @ 24V/40A for DRB-24V040ABN
- Flexible operating buffering voltage modes: Fixed mode at 22Vdc; Dynamic mode for Vin-1V
- Support parallel connection to extend buffering time



AR

CliQ^{II}

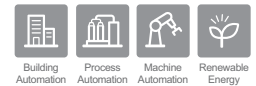

DC-UPS Module

- Full corrosion resistant aluminium casing
- Suitable for 24V system up to 40A
- Built-in diagnostic monitoring for DC OK, Discharge and Battery Fail by relay contacts
- LED indicator for DC OK, Battery Charging, Battery Discharging, Battery Fail and Battery Reverse Polarity



AR

CHROME

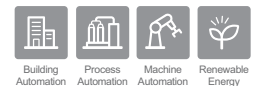

DC-UPS Module

- Suitable for 24V system up to 10A
- Zero switch over time from loss of DC input to battery operation
- Built-in diagnostic monitoring for DC OK, Discharge and Battery Fail by relay contacts
- LED indicator for DC OK, Battery Charging, Battery Discharging, Battery Fail and Battery Reverse Polarity



Features

- Wide input and output range of 22-60Vdc
- Very wide operating temperature from -40°C to +80°C
- Built-in 2 channel DC OK signal and alarm relay contact
- Support N+1 Redundancy connection
- Conformal coating on PCBAs to protect against common dust and chemical pollutants
- Hazardous Locations approval to ATEX and Class I, Div 2
- IP20 Certified

Specifications

OUTPUT		DRR-20Q	DRR-40Q
Output Current		Normal mode = 0-20Amps; Short Circuit or Overload = 25Amps max	Normal mode = 0-40Amps; Short Circuit or Overload = 50Amps max
Voltage Drop ($V_{in} - V_{out}$)		Typical 0.65V	
INPUT			
Input Voltage Range		22-60Vdc	
Input Current		(1+1 Redundancy) = Nom. 2 x 12.5Amps (N+1 Redundancy) = Nom. 2 x 10Amps (Single use) = Nom. 20Amps	(1+1 Redundancy) = Nom. 2 x 25Amps (N+1 Redundancy) = Nom. 2 x 20Amps (Single use) = Nom. 40Amps
MECHANICAL			
Case Cover / Chassis		Aluminium	
Dimensions (L x W x D)	mm	121 x 50 x 122.1	121 x 50 x 122.1
	inch	4.76 x 1.97 x 4.81	4.76 x 1.97 x 4.81
Unit Weight	kg	0.38	0.52
	lb	0.84	1.15
Cooling System		Convection	
LED Indicators		Green LED DC OK: V_{in1} and V_{in2}	
MTBF ¹⁾		> 800,000 hrs	> 800,000 hrs
ENVIRONMENT			
Operating Temperature ²⁾		-40°C to +80°C	
Storage Temperature		-40°C to +85°C	
Operating Humidity		5 to 95% RH (Non-Condensing)	
Operating Altitude		0 to 2,500 m (0 to 8,200 ft)	

Dimensions Reference

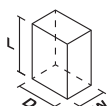

Notes

- 1) MTBF as per Telcordia SR-332 (Confidence level: 90%, I/P: 24Vdc, O/P: 100% load) for vertical mounting orientation.
- 2) Refer power de-rating in the product datasheet.
- 3) All parameters are specified at 25°C ambient temperature unless otherwise indicated.



Features

- Minimum buffering time of:
 - 250ms @ 24V/20A for DRB-24V020AB□
 - 200ms @ 24V/40A for DRB-24V040ABN
- Flexible operating buffering voltage modes:
 - Fixed mode at 22Vdc
 - Dynamic mode for $V_{in} - 1V$
- Support parallel connection to extend buffering time
- Conformal coating on PCBAs to protect against common dust and chemical pollutants
- Hazardous Locations approval to ATEX and Class I, Div 2 (DRB-24V020ABA)

Specifications

OUTPUT		DRB-24V020AB□	DRB-24V040ABN
Output Voltage		24Vdc typ. (Depends on V_{in})	24Vdc typ. (Depends on V_{in})
Output Voltage Range		22-28V (Switch = "Fix 22V" buffering starts if terminal voltage falls below 22V) (Switch = " $V_{in} - 1V$ " buffering starts if terminal voltage is decreased by more than 1V)	
Output Current		20.0A Max	40.0A Max
PARD (20MHz)		< 200mVpp, Buffering Mode	< 350mVpp, Buffering Mode
Buffer Time		> 250ms @ 24V/20A load, > 5s @ 24V/1A load	> 200ms @ 24V/40A load, > 8s @ 24V/1A load
INPUT			
Input Voltage Range		22.8-28.8Vdc	
Input Current		Charging Mode: < 0.6A	Charging Mode: < 0.6A
Input Power		2.5W average (Standby Mode)	
Charging Time		< 30s	< 40s
Polarity Protection		Yes	Yes
MECHANICAL			
Case Cover / Chassis		Aluminium	
Dimensions (L × W × D)	mm	121 × 70 × 120.1	121 × 70 × 120.1
	inch	4.76 × 2.76 × 4.73	4.76 × 2.76 × 4.73
Unit Weight	kg	0.76	0.90
	lb	1.68	1.98
Cooling System		Convection	
LED Indicators		Green LED Off = Unit is discharged or $V_{in} < 22Vdc$ Green LED On = Unit is fully charged (Ready) Green LED Flashing Slowly (1Hz) = Unit is charging Green LED Flashing Quickly (10Hz) = Unit is discharging (Buffering)	
MTBF ¹⁾		> 800,000 hrs	> 800,000 hrs
ENVIRONMENT			
Operating Temperature ²⁾		-25°C to +75°C	
Storage Temperature		-25°C to +85°C	
Operating Humidity		5 to 95% RH (Non-Condensing)	
Operating Altitude		0 to 2,500 m (0 to 8,200 ft)	

Dimensions Reference

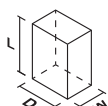

Notes

- 1) MTBF as per Telcordia SR-332 (Confidence level: 90%, I/P: 24Vdc, O/P: 100% load) for vertical mounting orientation.
- 2) Refer power de-rating in the product datasheet.
- 3) All parameters are specified at 25°C ambient temperature unless otherwise indicated.



Features

- Full corrosion resistant aluminium casing
- Suitable for 24V system up to 40A
- Built-in diagnostic monitoring for DC OK, Discharge and Battery Fail by relay contacts
- LED indicator for DC OK, Battery Charging, Battery Discharging, Battery Fail and Battery Reverse Polarity
- High MTBF > 500,000 hrs per Telcordia SR-332
- Conformal coating option on PCBAs to protect against common dust and chemical pollutants



Specifications

OUTPUT		DRU-24V40ABN
Output Voltage Range		23-28Vdc
Output Current		40.0A Max
Output Power		960W Max
INPUT		
Input Voltage Range		24-28Vdc
Input Current		Charging Mode: 2.0A ± 1.0A
Charging Time		< 3hr ± 1 hr (for battery 24V/15AH)
Efficiency		Charging Mode: > 70.0% Buffering Mode: > 99.0%
MECHANICAL		
Case Cover / Chassis		Aluminium
Dimensions (L × W × D)	mm	121 × 50 × 117.3
	inch	4.76 × 1.97 × 4.62
Unit Weight	kg	0.60
	lb	1.32
Cooling System		Convection
LED Indicators		Green LED ON = Battery is fully charged Green LED Flashing = Battery is charging Orange LED ON = Battery 24V or DC 24V reverse polarity Orange LED Flashing = Battery is discharging Red LED ON = Battery fail (no battery is connected)
MTBF ¹⁾		> 500,000 hrs
ENVIRONMENT		
Operating Temperature		-20°C to +60°C
Storage Temperature		-40°C to +85°C
Operating Humidity		5 to 95% RH (Non-Condensing)
Operating Altitude		0 to 3,000 m (0 to 9,840 ft)

Dimensions Reference

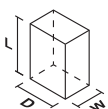

Notes

- 1) MTBF as per Telcordia SR-332 (Confidence level: 90%, I/P: 24Vdc, O/P: 100% load) for vertical mounting orientation.
- 2) Refer power de-rating in the product datasheet.
- 3) All parameters are specified at 25°C ambient temperature unless otherwise indicated.

CHROME

Features



- Suitable for 24V system up to 10A
- Zero switch over time from loss of DC input to battery operation
- Built-in diagnostic monitoring for DC OK, Discharge and Battery Fail by relay contacts
- Full power for the entire temperature range from -20°C to +60°C
- LED indicator for DC OK, Battery Charging, Battery Discharging, Battery Fail and Battery Reverse Polarity
- High MTBF > 500,000 hrs as per Telcordia SR-332

Specifications

OUTPUT		DRU-24V10ACZ
Output Voltage Range		23-28Vdc
Output Current		10.0A Max
Output Power		240W Max
INPUT		
Input Voltage Range		24-28Vdc
Input Current		Charging Mode: 0.5A ± 0.1A
Charging Time		< 25hr ± 5 hr (for battery 24V/12AH)
Efficiency		Charging Mode: > 70.0% Buffering Mode: > 99.0%
MECHANICAL		
Case Cover / Chassis		Plastic
Dimensions (L × W × D)	mm	91 × 71 × 55.6
	inch	3.58 × 2.80 × 2.19
Unit Weight	kg	0.14
	lb	0.31
Cooling System		Convection
LED Indicators		Green LED ON = Battery is fully charged Green LED Flashing = Battery is charging Orange LED ON = Battery 24V or DC 24V reverse polarity Orange LED Flashing = Battery is discharging Red LED ON = Battery fail (no battery is connected)
MTBF ¹⁾		> 500,000 hrs
ENVIRONMENT		
Operating Temperature		-20°C to +60°C
Storage Temperature		-40°C to +85°C
Operating Humidity		5 to 95% RH (Non-Condensing)
Operating Altitude		0 to 3,000 m (0 to 9,840 ft)

Dimensions Reference

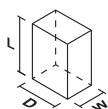

Notes

- 1) MTBF as per Telcordia SR-332 (Confidence level: 90%, I/P: 24Vdc, O/P: 100% load) for vertical mounting orientation.
- 2) Refer power de-rating in the product datasheet.
- 3) All parameters are specified at 25°C ambient temperature unless otherwise indicated.

INDUSTRIAL POWER SUPPLIES

| Adapter



ADT

- Up to 89% efficiency
- Meet ErP Lot 7 & DoE VI
- No load power consumption < 0.15W
- Over-Voltage/Load/Temperature & Short Circuit protections



ADT

Features

- Up to 89% efficiency
- Meet ErP Lot 7 & DoE VI
- No load power consumption < 0.15W
- Over-Voltage/Load/Temperature & Short Circuit protections



Specifications

OUTPUT		ADT-060A12A	ADT-060A15A	ADT-060A19A	ADT-060A24A
Output Voltage		12V	15V	19V	24V
Output Current (Max)		5.0A	4.0A	3.2A	2.5A
Output Power		60W	60W	60.8W	60W
PARD (20MHz)		< 240mVpp @ 0°C to +40°C, < 480mVpp @ -10°C to 0°C	< 300mVpp @ 0°C to +40°C, < 600mVpp @ -10°C to 0°C	< 380mVpp @ 0°C to +40°C, < 760mVpp @ -10°C to 0°C	< 480mVpp @ 0°C to +40°C, < 960mVpp @ -10°C to 0°C
Hold-up Time	115Vac	12ms typ.	12ms typ.	12ms typ.	12ms typ.
	230Vac	60ms typ.	60ms typ.	60ms typ.	60ms typ.
INPUT					
Input Voltage Range	85-264Vac				
Input Frequency	47-63Hz				
Input Current	115Vac	< 1.4A	< 1.4A	< 1.4A	< 1.4A
	230Vac	< 1.0A	< 1.0A	< 1.0A	< 1.0A
Efficiency at 100% Load	115Vac	87.6% typ.	87.9% typ.	88.1% typ.	88.8% typ.
	230Vac	90.2% typ.	90.0% typ.	90.3% typ.	90.1% typ.
Max Inrush Current (Cold Start)	No damage				
Leakage Current	240Vac	< 0.1mA	< 0.1mA	< 0.1mA	< 0.1mA
MECHANICAL					
Dimensions (L × W × H)	mm	108 × 46 × 29.5	108 × 46 × 29.5	108 × 46 × 29.5	108 × 46 × 29.5
	inch	4.25 × 1.81 × 1.16	4.25 × 1.81 × 1.16	4.25 × 1.81 × 1.16	4.25 × 1.81 × 1.16
Unit Weight	kg	0.18	0.18	0.18	0.18
	lb	0.40	0.40	0.40	0.40
Connector Type	ADT-060A□AA B: Input: C6; Output: Barrel type ADT-060A□AB B: Input: C8; Output: Barrel type				
Cooling System	Convection				
MTBF ¹⁾		700,000 hrs	700,000 hrs	700,000 hrs	700,000 hrs
ENVIRONMENT					
Operating Temperature ²⁾	-10°C to +60°C				
Storage Temperature	-40°C to +85°C				
Operating Humidity	5 to 95% RH (Non-Condensing)				
Operating Altitude	0 to 5,000 m (0 to 16,400 ft)				
Protection Against Shock	Class II				

Dimensions Reference

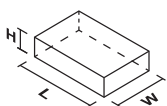

Notes

- 1) MTBF as per Telcordia SR-332 (I/P: 115Vac, O/P: 100% load).
- 2) Refer power de-rating in the product datasheet.
- 3) All parameters are specified at 25°C ambient temperature unless otherwise indicated.

| NOTES

Medical Power Supplies



PRODUCT OVERVIEW

Delta provides high quality power supplies for various healthcare and medical applications. The products are produced in factories certified to medical Quality Management System ISO 13485. Designs are compliant to medical IEC 60601-1-2 Ed. 4 requirements and are suitable for Type BF medical products.



Enclosed

Encased in strong metal casing, the Medical Enclosed power supplies can be used in a wide variety of equipment for medical and industrial applications.



Open Frame

The Medical Open Frame provides high performance and reliable solution as an internal power supply for various types of medical equipment.



ATX

Highly reliable design with ATX standard form factor and output cable pin-outs. Certified with medical standards and suitable for use in medical devices with Type BF classification.



Configurable

The MEG configurable power supply is designed for use in both medical and industrial applications. It supports up to 6 isolated output. The products can be configured for output voltages ranging from 2Vdc to 60Vdc.



Adapter

The Medical Adapter rides on Delta's market leading adapter technology to provide the same high quality external power supplies for medical systems and equipments.

MEDICAL POWER SUPPLIES

| Enclosed Power Supply



AR

MDS



- Compliant with IEC 60601-1-2 Ed. 4 requirements
- Suitable for type BF medical product
- Remote on/off control
- Power Good signal



AR

MEB



- 2 × MOPP isolation, Suitable for type BF medical products
- Compliant with IEC 60601-1-2 Ed. 4 requirements
- PMBus Ver 1.3 supported
- Intelligent fan speed control
- Safety approvals for medical and IT applications

MDS

Features

- Universal AC input voltage range
- Safety approvals for medical and IT applications
- Compliant with IEC 60601-1-2 Ed. 4 requirements
- Class B EMI; 4th Edition Immunity Compliance
- Suitable for type BF medical product
- 2 × MOPP isolation
- Power Good signal



Specifications

OUTPUT		MDS-200ADB12	MDS-250ADB12	MDS-300ADB12	MDS-400ADB12	MDS-300ADB18
Output Voltage		12V	12V	12V	12V	18V
Output Current (Max)		9.17A (Convection) 16.67A (with 8.5CFM Forced Air)	12.5A (Convection) 20.84A (with 10CFM Forced Air)	15.83A (Convection) 25.0A (with 10CFM Forced Air)	33.33A (with 20CFM Forced Air)	10.55A (Convection) 16.66A (with 10CFM Forced Air)
Output Power		110W (Convection) 200W (with 8.5CFM Forced Air)	150W (Convection) 250W (with 10CFM Forced Air)	190W (Convection) 300W (with 10CFM Forced Air)	400W (with 20CFM Forced Air)	190W (Convection) 300W (with 10CFM Forced Air)
Load Regulation		± 1%				
Ripple & Noise		1% typ. pk-pk Vrated @ Full load	1% typ. pk-pk Vrated @ Full load	1% typ. pk-pk Vrated @ Full load	150mV pk-pk Vrated @ Full load	1% typ. pk-pk Vrated @ Full load
INPUT						
Input Voltage Range		90-264Vac				
Input Frequency		47-63Hz				
Efficiency	115Vac (60Hz)	91.0% typ.	89.45% typ	91.3% typ.	89.5% typ.	92.5% typ.
	230Vac (50Hz)	93.0% typ.	90.5% typ.	92.6% typ.	91.5% typ.	93.5% typ.
Leakage Current ¹⁾	264Vac	Input-PE: < 0.1mA @ NC, < 0.3mA @ SFC Output-PE: < 0.1mA @ NC, < 0.5mA @ SFC	Input-PE: < 0.1mA @ NC, < 0.3mA @ SFC Output-PE: < 0.1mA @ NC, < 0.5mA @ SFC	Input-PE: < 0.1mA @ NC, < 0.3mA @ SFC Output-PE: < 0.1mA @ NC, < 0.5mA @ SFC	Input-PE: < 0.1mA @ NC, < 0.3mA @ SFC Output-PE: < 0.1mA @ NC, < 0.5mA @ SFC	Input-PE: < 0.1mA @ NC, < 0.3mA @ SFC Output-PE: < 0.1mA @ NC, < 0.5mA @ SFC
MECHANICAL						
Dimensions (L × W × H)	mm	113.9 × 64.7 × 44.7	140 × 88.9 × 44.4	140 × 88.9 × 44.4	140 × 88.9 × 44.4	140 × 88.9 × 44.4
	inch	4.48 × 2.55 × 1.76	5.51 × 3.50 × 1.75	5.51 × 3.50 × 1.75	5.51 × 3.50 × 1.75	5.51 × 3.50 × 1.75
Unit Weight	kg	0.35	0.61	0.61	0.61	0.61
	lb	0.76	1.35	1.35	1.35	1.35
MTBF ²⁾		800,000 hrs	500,000 hrs	800,000 hrs	500,000 hrs	800,000 hrs
EMC & Emissions		EN 55011/EN 55032, FCC Title 47: Class B				
ENVIRONMENT						
Operating Temperature ³⁾		-10°C to +70°C				
Storage Temperature		-40°C to +85°C				
Operating Humidity		5 to 95% RH (Non-Condensing)				
Operating Altitude		0 to 5,000 m (0 to 16,400 ft)				
MEDICAL RATING						
Float Rating		BF				
MOPP		2 × MOPP				

Dimensions Reference

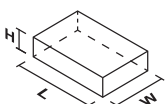

Notes

- 1) NC: normal condition, SFC: single fault condition.
- 2) MTBF as per Telcordia SR-332 (I/P: 115Vac, O/P: Load at Convection Air Flow, Ta: 35°C).
For MDS-400ADB12, MTBF as per Telcordia SR-332 (I/P: 115Vac, O/P: 100% load with 20CFM Forced Air, Ta: 35°C).
- 3) Refer power de-rating in the product datasheet.

MDS

Features

- Universal AC input voltage range
- Safety approvals for medical and IT applications
- Compliant with IEC 60601-1-2 Ed. 4 requirements
- Class B EMI; 4th Edition Immunity Compliance
- Suitable for type BF medical product
- 2 × MOPP isolation
- Power Good signal



Specifications

OUTPUT		MDS-200ADB24	MDS-250ADB24	MDS-300ADB24	MDS-400ADB24	MDS-300ADB48
Output Voltage		24V	24V	24V	24V	48V
Output Current (Max)		5.0A (Convection) 8.33A (with 5.5CFM Forced Air)	5.62A (Convection) 10.41A (with 10CFM Forced Air)	8.75A (Convection) 12.5A (with 10CFM Forced Air)	16.67A (with 16CFM Forced Air)	4.375A (Convection) 6.25A (with 10CFM Forced Air)
Output Power		120W (Convection) 200W (with 5.5CFM Forced Air)	150W (Convection) 250W (with 10CFM Forced Air)	210W (Convection) 300W (with 10CFM Forced Air)	400W (with 16CFM Forced Air)	210W (Convection) 300W (with 10CFM Forced Air)
Load Regulation		± 1%				
Ripple & Noise		1% typ. pk-pk Vrated @ Full load	1% typ. pk-pk Vrated @ Full load	1% typ. pk-pk Vrated @ Full load	1% typ. pk-pk Vrated @ Full load	1% typ. pk-pk Vrated @ Full load
INPUT						
Input Voltage Range		90-264Vac				
Input Frequency		47-63Hz				
Efficiency	115Vac (60Hz)	92.0% typ.	91.85% typ.	93.0% typ.	92.0% typ.	92.5% typ.
	230Vac (50Hz)	93.0% typ.	92.98% typ.	94.0% typ.	93.0% typ.	93.5% typ.
Leakage Current ¹⁾	264Vac	Input-PE: < 0.1mA @ NC, < 0.3mA @ SFC Output-PE: < 0.1mA @ NC, < 0.5mA @ SFC	Input-PE: < 0.1mA @ NC, < 0.3mA @ SFC Output-PE: < 0.1mA @ NC, < 0.5mA @ SFC	Input-PE: < 0.1mA @ NC, < 0.3mA @ SFC Output-PE: < 0.1mA @ NC, < 0.5mA @ SFC	Input-PE: < 0.1mA @ NC, < 0.3mA @ SFC Output-PE: < 0.1mA @ NC, < 0.5mA @ SFC	Input-PE: < 0.1mA @ NC, < 0.3mA @ SFC Output-PE: < 0.1mA @ NC, < 0.5mA @ SFC
		Input-PE: < 0.1mA @ NC, < 0.3mA @ SFC Output-PE: < 0.1mA @ NC, < 0.5mA @ SFC	Input-PE: < 0.1mA @ NC, < 0.3mA @ SFC Output-PE: < 0.1mA @ NC, < 0.5mA @ SFC	Input-PE: < 0.1mA @ NC, < 0.3mA @ SFC Output-PE: < 0.1mA @ NC, < 0.5mA @ SFC	Input-PE: < 0.1mA @ NC, < 0.3mA @ SFC Output-PE: < 0.1mA @ NC, < 0.5mA @ SFC	Input-PE: < 0.1mA @ NC, < 0.3mA @ SFC Output-PE: < 0.1mA @ NC, < 0.5mA @ SFC
MECHANICAL						
Dimensions (L × W × H)	mm	113.9 × 64.7 × 44.7	140 × 88.9 × 44.4	140 × 88.9 × 44.4	140 × 88.9 × 44.4	140 × 88.9 × 44.4
	inch	4.48 × 2.55 × 1.76	5.51 × 3.50 × 1.75	5.51 × 3.50 × 1.75	5.51 × 3.50 × 1.75	5.51 × 3.50 × 1.75
Unit Weight	kg	0.35	0.61	0.61	0.61	0.61
	lb	0.76	1.35	1.35	1.35	1.35
MTBF ²⁾		800,000 hrs	500,000 hrs	800,000 hrs	500,000 hrs	800,000 hrs
EMC & Emissions		EN 55011/EN 55032, FCC Title 47: Class B				
ENVIRONMENT						
Operating Temperature ³⁾		-10°C to +70°C				
Storage Temperature		-40°C to +85°C				
Operating Humidity		5 to 95% RH (Non-Condensing)				
Operating Altitude		0 to 5,000 m (0 to 16,400 ft)				
MEDICAL RATING						
Float Rating		BF				
MOPP		2 × MOPP				

Dimensions Reference

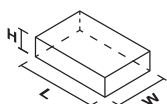

Notes

- 1) NC: normal condition, SFC: single fault condition.
- 2) MTBF as per Telcordia SR-332 (I/P: 115Vac, O/P: Load at Convection Air Flow, Ta: 35°C). For MDS-400ADB24, MTBF as per Telcordia SR-332 (I/P: 115Vac, O/P: 100% load with 10CFM Forced Air, Ta: 35°C).
- 3) Refer power de-rating in the product datasheet.

MEB

Features

- Safety Approvals to IEC 60601-1 Ed. 3.1 & IEC 60950-1 & IEC 62368-1
- Compliant with IEC 60601-1-2 Ed. 4 requirements
- High Power Density
- Built-in Remote On/Off
- 5V/1A Standby Output
- 12V/0.5A Fan Output for System
- IT & Medical Safety Approvals



Specifications

		NEW
OUTPUT		MEB-500A24F
Output Voltage		24V
Output Current (Max)		21.0A
Output Power		500W
Load Regulation		< 150mV
Ripple & Noise		< 300mVpp @ 0°C to +50°C
INPUT		
Input Voltage Range		90-264Vac
Input Frequency		47-63Hz
Efficiency	230Vac (50Hz)	92.0% typ.
Leakage Current ¹⁾	264Vac	Input-PE: < 0.1mA @ NC, < 0.3mA @ SFC Output-PE: < 0.1mA @ NC, < 0.5mA @ SFC
MECHANICAL		
Dimensions (L × W × H)	mm	165.3 × 85.2 × 41
	inch	6.5 × 3.35 × 1.61
Unit Weight	kg	0.66
	lb	1.46
MTBF ²⁾		700,000 hrs
EMC & Emissions		EN 55011 & Compliant with EN 55032, FCC Title 47: Class B
ENVIRONMENT		
Operating Temperature ³⁾		-20°C to +70°C
Storage Temperature		-30°C to +80°C
Operating Humidity		20 to 90% RH (Non-Condensing)
Operating Altitude		IEC 60601-1: 0 to 3,000 m (0 to 9,840 ft) IEC 60950-1 & IEC 62368-1: 0 to 5,000 m (16,400 ft)
MEDICAL RATING		
Float Rating		BF
MOPP		2 × MOPP

Dimensions Reference

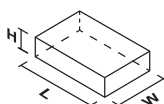

Notes

- 1) NC: normal condition, SFC: single fault condition.
- 2) MTBF as per Telcordia SR-332 (I/P: 115Vac, O/P: 100% load, Ta: 25°C).
- 3) Refer power de-rating in the product datasheet.

MEB

Features

- Up to 1200W in 5" × 8.03" × 1.59" package
- Full power from 90Vac to 264Vac, up to 50°C ambient
- Up to 500K hours MTBF
- 2 × MOPP isolation, Suitable for type BF medical products
- Current sharing and 5V/2A standby output
- Class B Conducted and Radiated EMI
- Compliant with IEC 60601-1-2 Ed. 4 requirements
- PMBus Ver 1.3 supported
- Intelligent fan speed control



Specifications

		NEW		
OUTPUT		MEB-1K2A24T	MEB-1K2A42T	MEB-1K2A48T
Output Voltage		24V	42V	48V
Output Current (Max)		50.0A	28.5A	25.0A
Output Power		1200W	1200W	1200W
Load Regulation		2%		
Ripple & Noise		1% typ. pk-pk Vrated @ rated load	1% typ. pk-pk Vrated @ rated load	1% typ. pk-pk Vrated @ rated load
INPUT				
Input Voltage Range		85-264Vac		
Input Frequency		47-63Hz		
Efficiency	115Vac (60Hz)	90.0% typ.	90.9% typ.	91.5% typ.
	230Vac (50Hz)	93.0% typ.	93.2% typ.	94.0% typ.
Leakage Current ¹⁾	264Vac	Input-PE: < 0.3mA @ NC, < 1mA @ SFC Output-PE: < 0.1mA @ NC, < 0.5mA @ SFC	Input-PE: < 0.3mA @ NC, < 1mA @ SFC Output-PE: < 0.1mA @ NC, < 0.5mA @ SFC	Input-PE: < 0.3mA @ NC, < 1mA @ SFC Output-PE: < 0.1mA @ NC, < 0.5mA @ SFC
MECHANICAL				
Dimensions (L × W × H)	mm	204 × 127 × 40.5	204 × 127 × 40.5	204 × 127 × 40.5
	inch	8.03 × 5.0 × 1.59	8.03 × 5.0 × 1.59	8.03 × 5.0 × 1.59
Unit Weight	kg	1.50	1.50	1.50
	lb	3.30	3.30	3.30
MTBF ²⁾		500,000 hrs	500,000 hrs	500,000 hrs
EMC & Emissions		EN 55011/EN 55032, FCC Title 47: Class B		
ENVIRONMENT				
Operating Temperature ³⁾		-20°C to +70°C		
Storage Temperature		-40°C to +85°C		
Operating Humidity		5 to 95% RH (Non-Condensing)		
Operating Altitude		0 to 5,000 m (0 to 16,400 ft)		
MEDICAL RATING				
Float Rating		BF		
MOPP		2 × MOPP		

Dimensions Reference

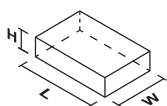

Notes

- 1) NC: normal condition, SFC: single fault condition.
- 2) MTBF as per Telcordia SR-332 (I/P: 115Vac, O/P: 100% load, Ta: 35°C).
- 3) Refer power de-rating in the product datasheet.

MEDICAL POWER SUPPLIES

| Open Frame Power Supply



AR

MDS



- Safety approvals for medical and IT applications
- Low touch current (< 0.1mA Normal & < 0.3mA Single Fault)
- Compliant with IEC 60601-1-2 Ed. 4 requirements
- Power Good Signal, Remote Sense, Remote inhibit
- 2 × MOPP isolation



AR

MEP



- Safety approvals to medical and IT applications
- Compliant with IEC 60601-1-2 Ed. 4 requirements
- Low touch current (< 70µA Normal & < 210µA Single Fault)
- 2 × MOPP isolation



AR

MEU



- 2 × MOPP isolation
- 5V/1A standby output and 12V/0.6A fan output
- Compliant with IEC 60601-1-2 Ed. 4 requirements
- PMBus Ver 1.3 Supported
- Safety approvals for medical and IT applications

MDS

Features

- Universal AC input voltage
- Safety approvals for medical and IT applications
- Over-Voltage/Load/Temperature & Short Circuit Protections
- Low touch current (< 0.1mA Normal & < 0.3mA Single Fault)
- Compliant with IEC 60601-1-2 Ed. 4 requirements
- 2 × MOPP isolation
- High MTBF

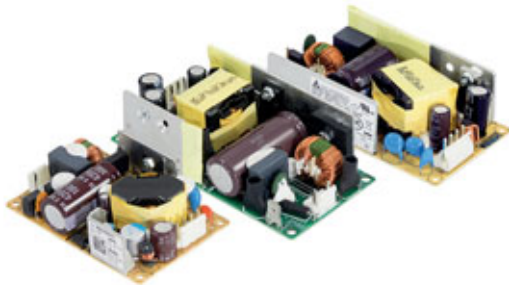

Specifications

OUTPUT	MDS-040APS12	MDS-065APS12	MDS-100APS12	MDS-100BPS12
Output Voltage	12V	12V	12V	12V
Output Current (Max)	3.33A	5.42A	8.33A	6.67A (Convection) 8.33A (with 10CFM Forced Air)
Output Power	40W	65W	100W	80W (Convection) 100W (with 10CFM Forced Air)
Load Regulation	± 1%			
Ripple & Noise	22.8mV pk-pk @ Full load	21.6mV pk-pk @ Full load	25mV pk-pk @ Full load	76mV pk-pk @ Full load
INPUT				
Input Voltage Range	90-264Vac			
Input Frequency	47-63Hz			
Efficiency	115Vac 230Vac	86.5% typ.	87.5% typ.	89.2% typ.
Touch Current ¹⁾	264Vac	< 0.1mA @ NC, < 0.3mA @ SFC	< 0.1mA @ NC, < 0.3mA @ SFC	< 0.1mA @ NC, < 0.3mA @ SFC
Leakage Current ¹⁾	264Vac	-	< 0.15mA @ NC, < 0.3mA @ SFC	< 0.15mA @ NC, < 0.3mA @ SFC
MECHANICAL				
Dimensions (L × W × H)	mm	76.2 × 50.8 × 23	101.6 × 50.8 × 30	127 × 76.2 × 31
	inch	3.00 × 2.00 × 0.91	4.00 × 2.00 × 1.18	5.00 × 3.00 × 1.22
Unit Weight	kg	0.08	0.13	0.21
	lb	0.18	0.29	0.46
MTBF ²⁾		3,000,000 hrs	2,500,000 hrs	3,000,000 hrs
EMC & Emissions	EN 55011/EN 55032, FCC Title 47: Class B			
ENVIRONMENT				
Operating Temperature ³⁾	-10°C to +70°C			
Storage Temperature	-40°C to +85°C			
Operating Humidity	10 to 95% RH (Non-Condensing)			
Operating Altitude	0 to 3,000 m (0 to 9,840 ft)			0 to 5,000 m (0 to 16,400 ft)
MEDICAL RATING				
Float Rating	BF			
MOPP	2 × MOPP			

Dimensions Reference

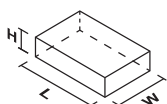

Notes

- 1) NC: normal condition, SFC: single fault condition.
- 2) MTBF as per Telcordia SR-332.
- 3) Refer power de-rating in the product datasheet.

MDS

Features

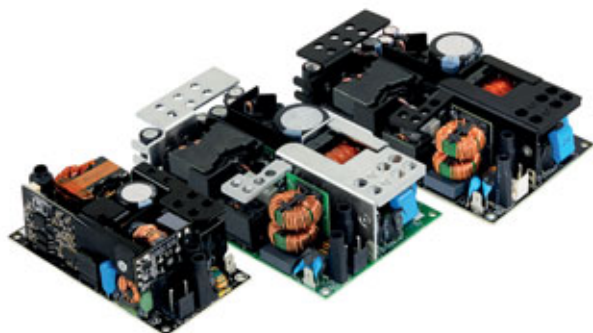

- Universal AC input voltage range
- Safety approvals for medical and IT applications
- Compliant with IEC 60601-1-2 Ed. 4 requirements
- Class B EMI; 4th Edition Immunity Compliance
- Enclosed cover design option available
- Suitable for type BF medical product
- 2 × MOPP isolation
- Power Good signal

Specifications

OUTPUT		MDS-200APB12	MDS-250APB12	MDS-300APB12	MDS-400APB12
Output Voltage		12V	12V	12V	12V
Output Current (Max)		10.83A (Convection) 16.67A (with 8.5CFM Forced Air)	12.5A (Convection) 20.84A (with 10CFM Forced Air)	18.33A (Convection) 25.0A (with 10CFM Forced Air)	33.33A (with 16CFM Forced Air)
Output Power		130W (Convection) 200W (with 8.5CFM Forced Air)	150W (Convection) 250W (with 10CFM Forced Air)	220W (Convection) 300W (with 10CFM Forced Air)	400W (with 16CFM Forced Air)
Load Regulation		± 2.5%	± 1%		
Ripple & Noise		1% typ. pk-pk Vrated @ Full load	1% typ. pk-pk Vrated @ Full load	1% typ. pk-pk Vrated @ Full load	150mV pk-pkV rated @ Full load
INPUT					
Input Voltage Range		90-264Vac			
Input Frequency		47-63Hz			
Efficiency	115Vac (60Hz)	91.0% typ.	89.45% typ.	91.3% typ.	89.5% typ.
	230Vac (50Hz)	93.0% typ.	90.5% typ.	92.6% typ.	91.5% typ.
Leakage Current ¹⁾	264Vac	Input-PE: < 0.1mA @ NC, < 0.3mA @ SFC Output-PE: < 0.1mA @ NC, < 0.5mA @ SFC	Input-PE: < 0.1mA @ NC, < 0.3mA @ SFC Output-PE: < 0.1mA @ NC, < 0.5mA @ SFC	Input-PE: < 0.1mA @ NC, < 0.3mA @ SFC Output-PE: < 0.1mA @ NC, < 0.5mA @ SFC	Input-PE: < 0.1mA @ NC, < 0.3mA @ SFC Output-PE: < 0.1mA @ NC, < 0.5mA @ SFC
MECHANICAL					
Dimensions (L × W × H)	mm	101.9 × 51.1 × 36.1	127.3 × 76.5 × 36.1	127.3 × 76.5 × 36.1	127.3 × 76.5 × 36.1
	inch	4.01 × 2.01 × 1.42	5.01 × 3.01 × 1.42	5.01 × 3.01 × 1.42	5.01 × 3.01 × 1.42
Unit Weight	kg	0.20	0.41	0.41	0.41
	lb	0.44	0.90	0.90	0.90
MTBF ²⁾		800,000 hrs	500,000 hrs	800,000 hrs	500,000 hrs
EMC & Emissions		EN 55011/EN 55032, FCC Title 47: Class B			
ENVIRONMENT					
Operating Temperature ³⁾		-10°C to +70°C			
Storage Temperature		-40°C to +85°C			
Operating Humidity		5 to 95% RH (Non-Condensing)			
Operating Altitude		0 to 5,000 m (0 to 16,400 ft)			
MEDICAL RATING					
Float Rating		BF			
MOPP		2 × MOPP			

Dimensions Reference

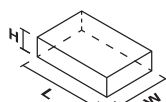

Notes

- 1) NC: normal condition, SFC: single fault condition.
- 2) MTBF as per Telcordia SR-332 (I/P: 115Vac, O/P: 100% load for Convection, Ta: 35°C).
For MDS-400APB12, MTBF as per Telcordia SR-332 (I/P: 115Vac, O/P: 100% load with 16CFM Forced Air, Ta: 35°C).
- 3) Refer power de-rating in the product datasheet.

MDS

Features

- Universal AC input voltage range
- Safety approvals for medical and IT applications
- Over-Voltage/Load/Temperature & Short Circuit Protections
- Low touch current (< 0.1mA Normal & < 0.3mA Single Fault)
- Compliant with IEC 60601-1-2 Ed. 4 requirements
- 2 × MOPP isolation
- High MTBF

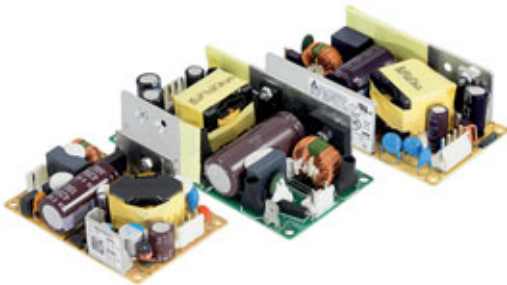

Specifications

OUTPUT	MDS-040APS15	MDS-065APS15	MDS-100APS15	MDS-100BPS15	
Output Voltage	15V	15V	15V	15V	
Output Current (Max)	2.67A	4.2A	6.67A	5.3A (Convection) 6.7A (with 10CFM Forced Air)	
Output Power	40W	63W	100W	80W (Convection) 100W (with 10CFM Forced Air)	
Load Regulation	± 1%				
Ripple & Noise	16.4mV pk-pk @ Full load	18mV pk-pk @ Full load	35.2mV pk-pk @ Full load	51.2mV pk-pk @ Full load	
INPUT					
Input Voltage Range	90-264Vac				
Input Frequency	47-63Hz				
Efficiency	115Vac 230Vac	87.2% typ.	89.2% typ.	90.6% typ.	
Touch Current ¹⁾	264Vac	< 0.1mA @ NC, < 0.3mA @ SFC	< 0.1mA @ NC, < 0.3mA @ SFC	< 0.1mA @ NC, < 0.3mA @ SFC	
Leakage Current ¹⁾	264Vac	-	< 0.15mA @ NC, < 0.3mA @ SFC	< 0.15mA @ NC, < 0.3mA @ SFC	
MECHANICAL					
Dimensions (L × W × H)	mm	76.2 × 50.8 × 23	101.6 × 50.8 × 30	127 × 76.2 × 31	101.6 × 50.8 × 31.8
	inch	3.00 × 2.00 × 0.91	4.00 × 2.00 × 1.18	5.00 × 3.00 × 1.22	4.00 × 2.00 × 1.25
Unit Weight	kg	0.08	0.13	0.21	0.15
	lb	0.18	0.29	0.46	0.33
MTBF ²⁾		3,000,000 hrs	2,500,000 hrs	3,000,000 hrs	1,000,000 hrs
EMC & Emissions	EN 55011/EN 55032, FCC Title 47: Class B				
ENVIRONMENT					
Operating Temperature	-10°C to +70°C				
Storage Temperature	-40°C to +85°C				
Operating Humidity	10 to 95% RH (Non-Condensing)				
Operating Altitude	0 to 3,000 m (0 to 9,840 ft)			0 to 5,000 m (0 to 16,400 ft)	
MEDICAL RATING					
Float Rating	BF				
MOPP	2 × MOPP				

Dimensions Reference

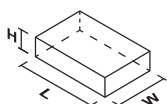

Notes

- 1) NC: normal condition, SFC: single fault condition.
- 2) MTBF as per Telcordia SR-332.
- 3) Refer power de-rating in the product datasheet.

MDS

Features

- Universal AC input voltage
- Safety approvals for medical and IT applications
- Over-Voltage/Load/Temperature & Short Circuit Protections
- Compliant with IEC 60601-1-2 Ed. 4 requirements
- Power Good signal, Remote Sense, Remote Inhibit (only MDS-300APB18)
- 2 × MOPP isolation



Specifications

OUTPUT		MDS-040APS18	MDS-065APS18	MDS-100APS18	MDS-100BPS18	MDS-300APB18
Output Voltage		18V	18V	18V	18V	18V
Output Current (Max)		2.22A	3.61A	5.55A	4.4A (Convection) 5.5A (with 10CFM Forced Air)	12.22A (Convection) 16.66A (with 10CFM Forced Air)
Output Power		40W	65W	100W	80W (Convection) 100W (with 10CFM Forced Air)	220W (Convection) 300W (with 10CFM Forced Air)
Load Regulation		± 1%				
Ripple & Noise		14.8mV pk-pk @ Full load	20.8mV pk-pk @ Full load	28.8mV pk-pk @ Full load	88mV pk-pk @ Full load	1% typ. pk-pk Vrated @ Full load
INPUT						
Input Voltage Range		90-264Vac				
Input Frequency		47-63Hz				
Efficiency	115Vac 230Vac	86.9% typ.	87.7% typ.	91.24% typ.	87.6% typ.	92.5% typ. 93.5% typ.
Touch Current ¹⁾	264Vac	< 0.1mA @ NC, < 0.3mA @ SFC	< 0.1mA @ NC, < 0.3mA @ SFC	< 0.1mA @ NC, < 0.3mA @ SFC	< 0.1mA @ NC, < 0.3mA @ SFC	-
Leakage Current ¹⁾	264Vac	-	-	< 0.15mA @ NC, < 0.3mA @ SFC	< 0.15mA @ NC, < 0.3mA @ SFC	Input-PE: < 0.1mA @ NC, < 0.3mA @ SFC Output-PE: < 0.1mA @ NC < 0.5mA @ SFC
MECHANICAL						
Dimensions L × W × H)	mm	76.2 × 50.8 × 23	101.6 × 50.8 × 30	127 × 76.2 × 31	101.6 × 50.8 × 31.8	127.3 × 76.5 × 36.1
	inch	3.00 × 2.00 × 0.91	4.00 × 2.00 × 1.18	5.00 × 3.00 × 1.22	4.00 × 2.00 × 1.25	5.01 × 3.01 × 1.42
Unit Weight	kg	0.08	0.13	0.21	0.15	0.41
	lb	0.18	0.29	0.46	0.33	0.90
MTBF ²⁾		3,000,000 hrs	2,500,000 hrs	3,000,000 hrs	1,000,000 hrs	800,000 hrs
EMC & Emissions		EN 55011/EN 55032, FCC Title 47: Class B				
ENVIRONMENT						
Operating Temperature ³⁾		-10°C to +70°C				
Storage Temperature		-40°C to +85°C				
Operating Humidity		10 to 95% RH (Non-Condensing)				5 to 95% RH (Non-Condensing)
Operating Altitude		0 to 3,000 m (0 to 9,840 ft)			0 to 5,000 m (0 to 16,400 ft)	
MEDICAL RATING						
Float Rating		BF				
MOPP		2 × MOPP				

Dimensions Reference

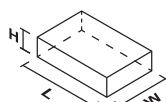

Notes

- 1) NC: normal condition, SFC: single fault condition.
- 2) MTBF as per Telcordia SR-332.
For MDS-300APB18, MTBF as per Telcordia SR-332 (I/P: 115Vac, O/P: 100% load for Convection, Ta: 35°C).
- 3) Refer power de-rating in the product datasheet.

MDS

Features



- Over-Voltage/Load/Temperature & Short Circuit Protections
- Low leakage current (< 0.1mA Normal & < 0.3mA Single Fault)
- Compliant with IEC 60601-1-2 Ed. 4 requirements
- Safety approvals for medical and IT applications
- High MTBF
- 2 × MOPP isolation
- Remote sense

Specifications

OUTPUT		MDS-400AUS19	MDS-400AUS24	MDS-400AUS30
Output Voltage		19V	24V	30V
Output Current (Max)		15.8A (Convection) 21.1A (with 200LFM Forced Air)	12.5A (Convection) 16.67A (with 200LFM Forced Air)	11.67A (Convection) 13.33A (with 200LFM Forced Air)
Output Power		300W (Convection) 400W (with 200LFM Forced Air)	300W (Convection) 400W (with 200LFM Forced Air)	350W (Convection) 400W (with 200LFM Forced Air)
Load Regulation		± 2%		
Ripple & Noise		±1% pk-pk @ Full load	±1% pk-pk @ Full load	±1.5% pk-pk @ Full load
INPUT				
Input Voltage Range		90-264Vac		
Input Frequency		47-63Hz		
Efficiency	115Vac 230Vac	91.38% typ.	91.94% typ.	92.51% typ.
Leakage Current ¹⁾	264Vac	< 0.1mA @ NC < 0.3mA @ SFC	< 0.1mA @ NC < 0.3mA @ SFC	< 0.1mA @ NC < 0.3mA @ SFC
MECHANICAL				
Dimensions (L × W × H)	mm	198 × 97 × 41.5	198 × 97 × 41.5	198 × 97 × 41.5
	inch	7.80 × 3.82 × 1.63	7.80 × 3.82 × 1.63	7.80 × 3.82 × 1.63
Unit Weight	kg	0.91	0.91	0.91
	lb	2.01	2.01	2.01
MTBF ²⁾		2,000,000 hrs	2,000,000 hrs	500,000 hrs
EMC & Emissions		EN 55011/EN 55032, FCC Title 47: Class B		
ENVIRONMENT				
Operating Temperature ³⁾		-10°C to +70°C		
Storage Temperature		-40°C to +85°C		
Operating Humidity		10 to 95% RH (Non-Condensing)		
Operating Altitude		0 to 3,000 m (0 to 9,840 ft)		0 to 5,000 m (0 to 16,400 ft)
MEDICAL RATING				
Float Rating		B		
MOPP		2 × MOPP		

Dimensions Reference

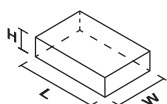

Notes

- 1) NC: normal condition, SFC: single fault condition.
- 2) MTBF as per Telcordia SR-332.
- 3) Refer power de-rating in the product datasheet.

MDS

Features

- Universal AC input voltage
- Safety approvals for medical and IT applications
- Over-Voltage/Load/Temperature & Short Circuit Protections
- Low touch current (< 0.1mA Normal & < 0.3mA Single Fault)
- Compliant with IEC 60601-1-2 Ed. 4 requirements
- 2 × MOPP isolation
- High MTBF

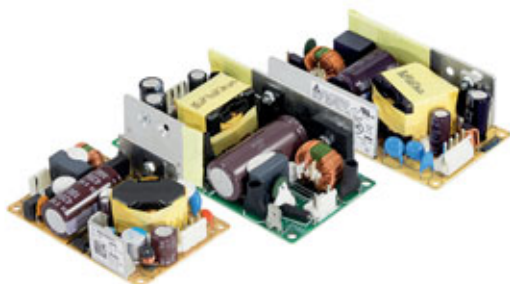

Specifications

OUTPUT		MDS-040APS24	MDS-065APS24	MDS-100APS24	MDS-100BPS24
Output Voltage		24V	24V	24V	24V
Output Current (Max)		1.67A	2.71A	4.17A	3.3A (Convection) 4.2A (with 10CFM Forced Air)
Output Power		40W	65W	100W	80W (Convection) 100W (with 10CFM Forced Air)
Load Regulation		± 1%			
Ripple & Noise		34mV pk-pk @ Full load	32.8mV pk-pk @ Full load	55.2 mV pk-pk @ Full load	58.4mV pk-pk @ Full load
INPUT					
Input Voltage Range		90-264Vac			
Input Frequency		47-63Hz			
Efficiency	115Vac 230Vac	86.3% typ.	88.4% typ.	91.08% typ.	89.3% typ.
Touch Current ¹⁾	264Vac	< 0.1mA @ NC, < 0.3mA @ SFC	< 0.1mA @ NC, < 0.3mA @ SFC	< 0.1mA @ NC, < 0.3mA @ SFC	< 0.1mA @ NC, < 0.3mA @ SFC
Leakage Current ¹⁾	264Vac	-	-	< 0.15mA @ NC, < 0.3mA @ SFC	< 0.15mA @ NC, < 0.3mA @ SFC
MECHANICAL					
Dimensions (L × W × H)	mm	76.2 × 50.8 × 23	101.6 × 50.8 × 30	127 × 76.2 × 31	101.6 × 50.8 × 31.8
	inch	3.00 × 2.00 × 0.91	4.00 × 2.00 × 1.18	5.00 × 3.00 × 1.22	4.00 × 2.00 × 1.25
Unit Weight	kg	0.08	0.13	0.21	0.15
	lb	0.18	0.29	0.46	0.33
MTBF ²⁾		3,000,000 hrs	2,500,000 hrs	3,000,000 hrs	1,000,000 hrs
EMC & Emissions		EN 55011/EN 55032, FCC Title 47: Class B			
ENVIRONMENT					
Operating Temperature ³⁾		-10°C to +70°C			
Storage Temperature		-40°C to +85°C			
Operating Humidity		10 to 95% RH (Non-Condensing)			
Operating Altitude		0 to 3,000 m (0 to 9,840 ft)			0 to 5,000 m (0 to 16,400 ft)
MEDICAL RATING					
Float Rating		BF			
MOPP		2 × MOPP			

Dimensions Reference

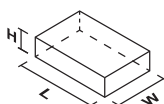

Notes

- 1) NC: normal condition, SFC: single fault condition.
- 2) MTBF as per Telcordia SR-332.
- 3) Refer power de-rating in the product datasheet.

MDS

Features

- Universal AC input voltage range
- Safety approvals for medical and IT applications
- Compliant with IEC 60601-1-2 Ed. 4 requirements
- Enclosed cover design option available
- Suitable for type BF medical product
- 2 × MOPP isolation
- Power Good signal



Specifications

OUTPUT		MDS-200APB24	MDS-250APB24	MDS-300APB24	MDS-400APB24	MDS-300APB48
Output Voltage		24V	24V	24V	24V	48V
Output Current (Max)		5.83A (Convection) 8.33A (with 5.5CFM Forced Air)	6.25A (Convection) 10.41A (with 10CFM Forced Air)	10.0A (Convection) 12.5A (with 10CFM Forced Air)	16.66A (with 10CFM Forced Air)	5.0A (Convection) 6.25A (with 10CFM Forced Air)
Output Power		140W (Convection) 200W (with 5.5CFM Forced Air)	150W (Convection) 250W (with 10CFM Forced Air)	240W (Convection) 300W (with 10CFM Forced Air)	400W (with 10CFM Forced Air)	240W (Convection) 300W (with 10CFM Forced Air)
Load Regulation		± 2.5%				± 1%
Ripple & Noise		1% typ. pk-pk Vrated @ Full load	1% typ. pk-pk Vrated @ Full load	1% typ. pk-pk Vrated @ Full load	1% typ. pk-pk Vrated @ Full load	1% typ. pk-pk Vrated @ Full load
INPUT						
Input Voltage Range		90-264Vac				
Input Frequency		47-63Hz				
Efficiency	115Vac (60Hz)	92.0% typ.	91.85% typ.	93.0% typ.	92.0% typ.	92.5% typ.
	230Vac (50Hz)	93.0% typ.	92.98% typ.	94.0% typ.	93.0% typ.	93.5% typ.
Leakage Current ¹⁾	264Vac	Input-PE: < 0.1mA @ NC, < 0.3mA @ SFC Output-PE: < 0.1mA @ NC, < 0.5mA @ SFC	Input-PE: < 0.1mA @ NC, < 0.3mA @ SFC Output-PE: < 0.1mA @ NC, < 0.5mA @ SFC	Input-PE: < 0.1mA @ NC, < 0.3mA @ SFC Output-PE: < 0.1mA @ NC, < 0.5mA @ SFC	Input-PE: < 0.1mA @ NC, < 0.3mA @ SFC Output-PE: < 0.1mA @ NC, < 0.5mA @ SFC	Input-PE: < 0.1mA @ NC, < 0.3mA @ SFC Output-PE: < 0.1mA @ NC, < 0.5mA @ SFC
		Input-PE: < 0.1mA @ NC, < 0.3mA @ SFC Output-PE: < 0.1mA @ NC, < 0.5mA @ SFC	Input-PE: < 0.1mA @ NC, < 0.3mA @ SFC Output-PE: < 0.1mA @ NC, < 0.5mA @ SFC	Input-PE: < 0.1mA @ NC, < 0.3mA @ SFC Output-PE: < 0.1mA @ NC, < 0.5mA @ SFC	Input-PE: < 0.1mA @ NC, < 0.3mA @ SFC Output-PE: < 0.1mA @ NC, < 0.5mA @ SFC	Input-PE: < 0.1mA @ NC, < 0.3mA @ SFC Output-PE: < 0.1mA @ NC, < 0.5mA @ SFC
MECHANICAL						
Dimensions (L × W × H)	mm	101.9 × 51.1 × 36.1	127.3 × 76.5 × 36.1	127.3 × 76.5 × 36.1	127.3 × 76.5 × 36.1	127.3 × 76.5 × 36.1
	inch	4.01 × 2.01 × 1.42	5.01 × 3.01 × 1.42	5.01 × 3.01 × 1.42	5.01 × 3.01 × 1.42	5.01 × 3.01 × 1.42
Unit Weight	kg	0.20	0.41	0.41	0.41	0.41
	lb	0.44	0.90	0.90	0.90	0.90
MTBF ²⁾		800,000 hrs	500,000 hrs	800,000 hrs	500,000 hrs	800,000 hrs
EMC & Emissions		EN 55011/EN 55032, FCC Title 47: Class B				
ENVIRONMENT						
Operating Temperature ³⁾		-10°C to +70°C				
Storage Temperature		-40°C to +85°C				
Operating Humidity		5 to 95% RH (Non-Condensing)				
Operating Altitude		0 to 5,000 m (0 to 16,400 ft)				
MEDICAL RATING						
Float Rating		BF				
MOPP		2 × MOPP				

Dimensions Reference

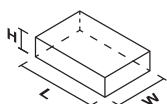

Notes

- 1) NC: normal condition, SFC: single fault condition.
- 2) MTBF as per Telcordia SR-332 (I/P: 115Vac, O/P: 100% load for Convection, Ta: 35°C). For MDS-400APB24, MTBF as per Telcordia SR-332 (Confidence level: 90%, I/P: 115Vac, O/P: 100% load with 10CFM Forced Air, Ta: 35°C).
- 3) Refer power de-rating in the product datasheet.

MDS

Features



- Safety approvals for medical and IT applications
- Over-Voltage/Load/Temperature & Short Circuit Protections
- Low leakage current (< 0.1mA Normal & < 0.3mA Single Fault)
- Compliant with IEC 60601-1-2 Ed. 4 requirements
- 1.4 million hours MTBF
- 2 × MOPP isolation

Specifications

OUTPUT		MDS-100AP401			
Output Voltage		5.1V	12V	-15V	15V
Output Current (Max)		4.0A (Convection) 8.0A (with 5CFM Forced Air)	2.0A (Convection) 3.0A (with 5CFM Forced Air)	0.6A (Convection) 0.8A (with 5CFM Forced Air)	0.8A (Convection) 0.8A (with 5CFM Forced Air)
Output Power		65W (Convection) 100W (with 5CFM Forced Air)			
Load Regulation		± 2%	± 1%	± 3%	
Ripple & Noise		36.8 mV pk-pk @ Full load	76.8 mV pk-pk @ Full load	12.8 mV pk-pk @ Full load	20.8 mV pk-pk @ Full load
INPUT					
Input Voltage Range		90-264Vac			
Input Frequency		47-63Hz			
Efficiency	115Vac 230Vac	79.34% typ.	79.34% typ.	79.34% typ.	79.34% typ.
Leakage Current ¹⁾	264Vac	< 0.1mA @ NC, < 0.3mA @ SFC	< 0.1mA @ NC, < 0.3mA @ SFC	< 0.1mA @ NC, < 0.3mA @ SFC	< 0.1mA @ NC, < 0.3mA @ SFC
MECHANICAL					
Dimensions (L × W × H)	mm	127 × 76.2 × 30.5			
	inch	5.00 × 3.00 × 1.20			
Unit Weight	kg	0.25			
	lb	0.55			
MTBF ²⁾		1,400,000 hrs			
EMC & Emissions		EN 55011/EN 55032, FCC Title 47: Class B			
ENVIRONMENT					
Operating Temperature ³⁾		-10°C to +70°C			
Storage Temperature		-40°C to +85°C			
Operating Humidity		5 to 95% RH (Non-Condensing)			
Operating Altitude		0 to 5,000 m (0 to 16,400 ft)			
MEDICAL RATING					
Float Rating		B			
MOPP		2 × MOPP			

Dimensions Reference

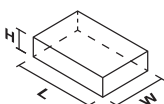

Notes

- 1) NC: normal condition, SFC: single fault condition.
- 2) MTBF as per Telcordia SR-332.
- 3) Refer power de-rating in the product datasheet.

MEP

Features

- Safety approvals for medical and IT applications
- Compliant with IEC 60601-1-2 Ed. 4 requirements
- Low touch current (< 70µA Normal & < 210µA Single Fault)
- Over-Voltage/Load/Temperature & Short Circuit protections
- 3 million hours MTBF
- 2 × MOPP isolation



Specifications

OUTPUT		MEP-25A15J
Output Voltage		15V
Output Current (Max)		1.67A
Output Power		25W
Load Regulation		± 0.5%
Ripple & Noise		120mV pk-pk @ Full load
INPUT		
Input Voltage Range		90-264Vac
Input Frequency		47-63Hz
Efficiency	230Vac	86.5% typ. @ Full load
Touch Current ¹⁾	240Vac	< 70µA @ NC, < 210µA @ SFC
MECHANICAL		
Dimensions (L × W × H)	mm	76.2 × 50.8 × 23
	inch	3.00 × 2.00 × 0.91
Unit Weight	kg	0.07
	lb	0.15
MTBF ²⁾		3,000,000 hrs
EMC & Emissions		EN 55011/EN 55032, FCC Title 47: Class B
ENVIRONMENT		
Operating Temperature ³⁾		-10°C to +70°C
Storage Temperature		-40°C to +85°C
Operating Humidity		5 to 95% RH (Non-Condensing)
Operating Altitude		0 to 5,000 m (0 to 16,400 ft)
MEDICAL RATING		
Float Rating		BF
MOPP		2 × MOPP

Dimensions Reference

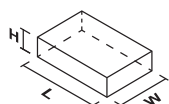

Notes

- 1) NC: normal condition, SFC: single fault condition.
- 2) MTBF as per Telcordia SR-332.
- 3) Refer power de-rating in the product datasheet.

MEU

Features

- Up to 600W convection cooled
- Full power from 90Vac to 264Vac, up to 50°C ambient
- Up to 500K hours MTBF
- 2 × MOPP isolation, Suitable for type BF medical products
- 5V/1A standby output and 12V/0.6A fan output for system
- Compliant with IEC 60601-1-2 Ed. 4 requirements
- PMBus Ver 1.3 supported



Specifications

OUTPUT		MEU-600C24T	MEU-600C48T
Output Voltage		24V	48V
Output Current (Max)		25.0A	12.5A
Output Power		600W	600W
Load Regulation		2%	
Ripple & Noise		1% typ. pk-pk Vrated @ Rated load	1% typ. pk-pk Vrated @ Rated load
INPUT			
Input Voltage Range		85-264Vac	85-264Vac
Input Frequency		47-63Hz	
Efficiency	115Vac (60Hz)	92.5% typ.	94.0% typ.
	230Vac (50Hz)	94.0% typ.	95.0% typ.
Leakage Current ¹⁾	264Vac	Input-PE: < 0.3mA @ NC, < 1mA @ SFC Output-PE: < 0.1mA @ NC, < 0.5mA @ SFC	Input-PE: < 0.3mA @ NC, < 1mA @ SFC Output-PE: < 0.1mA @ NC, < 0.5mA @ SFC
MECHANICAL			
Dimensions (L × W × H)	mm	203.2 × 127 × 40	203.2 × 127 × 40
	inch	8.00 × 5.00 × 1.57	8.00 × 5.00 × 1.57
Unit Weight	kg	1.30	1.30
	lb	2.87	2.87
MTBF ²⁾		500,000 hrs	500,000 hrs
EMC & Emissions		EN 55011/EN 55032, FCC Title 47: Class B	
ENVIRONMENT			
Operating Temperature ³⁾		-20°C to +70°C	
Storage Temperature		-40°C to +85°C	
Operating Humidity		5 to 95% RH (Non-Condensing)	
Operating Altitude		0 to 5,000 m (0 to 16,400 ft)	
MEDICAL RATING			
Float Rating		BF	
MOPP		2 × MOPP	

Dimensions Reference

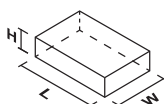

Notes

- 1) NC: normal condition, SFC: single fault condition.
- 2) MTBF as per Telcordia SR-332.
- 3) Refer power de-rating in the product datasheet.

MEDICAL POWER SUPPLIES

| ATX Power Supply



MDS



- Compliant with IEC 60601-1-2 Ed. 4 requirements
- Suitable for type BF patient access applications
- ATX 12V standard function & form factor
- Maximum output power of 350 watts
- Built-in active PFC
- Safety approvals for medical and IT applications

MDS

Features

- Universal AC input voltage range
- IEC 60601-1 3.1 Ed. (Medical) & IEC 60950-1 (ITE) approvals
- Compliant with IEC 60601-1-2 Ed. 4 requirements
- Suitable for type BF patient access applications
- ATX 12V standard function & form factor
- Maximum output power of 350 watts
- Built-in active PFC



Specifications

OUTPUT		MDS-350AD701						
Output Voltage		+3.3V	+5V	+5V _{SB}	+12V ₁	+12V ₂	-12V	-5V
Output Current (Nom)		8.0A	9.0A	1.25A	8.0A	8.0A	0.25A	0.1A
Output Power		350W						
Load Regulation		± 5%					± 10%	
Ripple & Noise		< 50mVpp	< 50mVpp	< 150mVpp	< 120mVpp	< 120mVpp	< 120mVpp	< 50mVpp
INPUT								
Input Voltage Range		90-264Vac						
Input Frequency		47-63Hz						
Efficiency	115Vac (60Hz)	82% typ.						
	230Vac (50Hz)	85% typ.						
Leakage Current ¹⁾		< 0.1mA @ NC, < 0.3mA @ SFC						
MECHANICAL								
Dimensions (L × W × H)	mm	100 × 194 × 40.5						
	inch	3.94 × 7.64 × 1.59						
Unit Weight	kg	1.20						
	lb	2.65						
MTBF ²⁾		500,000 hrs						
EMC & Emissions		EN 55011/EN 55032, FCC Title 47: Class B						
ENVIRONMENT								
Operating Temperature ³⁾		0°C to +50°C						
Storage Temperature		-40°C to +85°C						
Operating Humidity		5 to 95% RH (Non-Condensing)						
Operating Altitude		0 to 5,000 m (0 to 16,400 ft)						
MEDICAL RATING								
Float Rating		BF						
MOPP		2 × MOPP						

Dimensions Reference

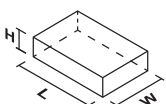

Notes

- 1) NC: normal condition, SFC: single fault condition.
- 2) MTBF as per Telcordia SR-332 (I/P: 115Vac, O/P: 100% load, Ta: 35°C).
- 3) Refer power de-rating in the product datasheet.

MEDICAL POWER SUPPLIES

| Configurable Power Supply



AR

MEG

- 2 × MOPP isolation
- Output selectable from 2Vdc to 60Vdc
- Normal and Reversed Option for Global Remote On/Off
- Analog and Digital Voltage Trimming
- PMBus Ver 1.3 Supported
- Safety approvals for medical and IT applications



MEG

Features

- Compact size and High Power Density
- 2 × MOPP isolation
- Output selectable from 2Vdc to 60Vdc
- Optional CV/CC Version on demand
- Normal and Reversed Option for Global Remote On/Off
- Analog and Digital Voltage Trimming
- PMBus Ver 1.3 Supported
- Optional RS485/RS232/USB Communication Adapters



Specifications

		NEW	
OUTPUT		MEG-1K2A4	MEG-2K1A6
Output Slots		4 Slots	6 Slots
Output Module		Single Slot / Triple Slot	Single Slot / Triple Slot
Output Numbers		Single Output / Dual Output	Single Output / Dual Output
Output Voltage		2V-60V	2V-60V
Output Power (Max)		1,200W	2,100W
Line Regulation			± 0.5%
Load Regulation			± 1%
Ripple & Noise		< 1% Vrated pk-pk or 100mV, which is larger	< 1% Vrated pk-pk or 100mV, which is larger
Hold-up Time		12ms @ 115Vac	12ms @ 115Vac
Dynamic Response		± 5% @ with 50-100% load change	± 5% @ with 50-100% load change
Remote Sense		Up to 500mV compensation for voltage drop across	Up to 500mV compensation for voltage drop across
INPUT			
Input Voltage Range		90-264Vac	
Input Frequency		47-63Hz	
Input Current		< 8.5A	< 15A
Input Surge Voltage (Max)		300Vac for 100ms	300Vac for 100ms
Efficiency	115Vac	90%	90%
	230Vac	93%	93%
Inrush Current (Cold Start)	230Vac	40A	40A
Power Factor	115Vac	> 0.95 @ Full load	
	230Vac	> 0.95 @ Full load	
Patient Leakage Current ¹⁾		< 0.1mA @ NC, < 0.5mA @ SFC	< 0.1mA @ NC, < 0.5mA @ SFC
Earth Leakage Current ¹⁾		< 0.3mA @ NC, < 1mA @ SFC	< 0.3mA @ NC, < 1mA @ SFC
MECHANICAL			
Dimensions (L × W × H)	mm	254 × 88.9 × 40.5	254 × 127 × 40.5
	inch	10.00 × 3.50 × 1.59	10.00 × 5.00 × 1.59
Unit Weight	kg	1.30	2.00
	lb	2.86	4.41
MTBF ²⁾		500,000 hrs	500,000 hrs
EMC & Emissions		EN 55011/EN 55032, FCC Title 47: Class B	
ENVIRONMENT			
Operating Temperature ³⁾		-20°C to +70°C	
Storage Temperature		-40°C to +85°C	
Operating Humidity		5 to 95% RH (Non-Condensing)	
Operating Altitude		0 to 5,000 m (0 to 16,400 ft)	
MEDICAL RATING			
Float Rating		B	
MOPP		2 × MOPP	

Dimensions Reference

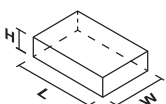

Notes

- 1) NC: normal condition, SFC: single fault condition.
- 2) MTBF as per Telcordia SR-332 (I/P: 150Vac, O/P: 1,200W for MEG-1K2A4 / 1,800W for MEG-2K1A6, Ta: 35°C).
- 3) Refer power de-rating in the product datasheet.

MEDICAL POWER SUPPLIES

| Adapter



MDS



- Safety approvals for medical and IT applications
- Over-Voltage/Load/Temperature & Short Circuit Protections
- Low touch current (< 0.1mA Normal & < 0.3mA Single Fault)
- Compliant with IEC 60601-1-2 Ed. 4 requirements
- 2 × MOPP isolation



MEA



- Compact Size and High Power Density
- High Efficiency meet DoE VI
- 2 × MOPP isolation
- High MTBF
- Safety approvals for medical and IT applications



MEF



- Compliant with IEC 60601-1-2 Ed. 4 requirements
- Meets Limited Power Source (LPS) requirements
- IP22 ingress protection rating
- 2 × MOPP isolation
- Safety approvals for medical and IT applications

MDS

Features

- Universal AC input voltage range
- Over-Voltage/Load/Temperature & Short Circuit Protections
- Compliant with IEC 60601-1-2 Ed. 4 requirements
- Safety approvals for medical and IT applications
- Low touch current (< 0.1mA Normal & < 0.3mA Single Fault)
- IP22 Ingress Protection Rating
- 2 × MOPP isolation



Specifications

OUTPUT		MDS-005AAS05	MDS-030AAC05	MDS-005AAS06	MDS-030AAC07
Output Voltage		5V	5V	6V	7V
Output Current (Max)		1.0A	3.0A	0.83A	3.0A
Output Power		5W	15W	5W	21W
Load Regulation		± 8%	± 5%	± 8%	± 5%
Ripple & Noise		88mV pk-pk @ Full load	< 100mV pk-pk @ Rated load	111.2mV pk-pk @ Full load	< 100mV pk-pk @ Rated load
INPUT					
Input Voltage Range		90-264Vac	85-264Vac	90-264Vac	85-264Vac
Input Frequency		47-63Hz			
Average Efficiency	115Vac 230Vac	73.63%	81.4%	72.4%	81.4%
Touch Current ¹⁾	264Vac	< 0.1mA @ NC, < 0.3mA @ SFC	< 0.1mA @ NC, < 0.3mA @ SFC	< 0.1mA @ NC, < 0.3mA @ SFC	< 0.1mA @ NC, < 0.3mA @ SFC
Leakage Current ¹⁾	264Vac	-	< 0.1mA @ NC, < 0.5mA @ SFC	-	< 0.1mA @ NC, < 0.5mA @ SFC
MECHANICAL					
Dimensions (L × W × H)	mm	56.5 × 39.5 × 28	88 × 53.5 × 27.5	56.5 × 39.5 × 28	88 × 53.5 × 27.5
	inch	2.22 × 1.56 × 1.10	3.46 × 2.11 × 1.08	2.22 × 1.56 × 1.10	3.46 × 2.11 × 1.08
Unit Weight	kg	0.10	0.15	0.10	0.15
	lb	0.22	0.33	0.22	0.33
Connector Type		MDS-005AAS□: Input: Wall mount – US & EU & CN type; Output: O type/Barrel type/Tuning fork type/Micro USB-B type MDS-030AAC□: Input: Wall mount-CN/US/EU/UK/AU/KR/IN/AR/BZ/SA; Output: Barrel type/Tuning fork type			
MTBF ²⁾		1,000,000 hrs	500,000 hrs	1,000,000 hrs	500,000 hrs
EMC & Emissions		EN 55011/EN 55032, FCC Title 47: Class B			
ENVIRONMENT					
Operating Temperature ³⁾		0°C to +40°C			
Storage Temperature		-40°C to +85°C			
Operating Humidity		5 to 95% RH (Non-Condensing)			
Operating Altitude		0 to 3,000 m (0 to 9,840 ft)	0 to 5,000 m (0 to 16,400 ft)	0 to 3,000 m (0 to 9,840 ft)	0 to 5,000 m (0 to 16,400 ft)
Degree of Protection		IP22			
Protection Against Shock		Class II			
MEDICAL RATING					
Float Rating		BF			
MOPP		2 × MOPP			

Dimensions Reference

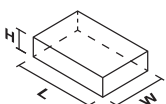

Notes

- 1) NC: normal condition, SFC: single fault condition.
- 2) MTBF as per Telcordia SR-332 (I/P: 100Vac, O/P: 100% load, Ta: 25°C).
- 3) Refer power de-rating in the product datasheet.

MDS

Features

- Universal AC input voltage range
- Over-Voltage/Load/Temperature & Short Circuit Protections
- Low touch current (< 0.1mA Normal & < 0.3mA Single Fault)
- Compliant with IEC 60601-1-2 Ed. 4 requirements
- Safety approvals for medical and IT applications
- 2 × MOPP isolation



Specifications

OUTPUT		MDS-030AAC12	MDS-060AAS12	MDS-060BAS12	MDS-080AAS12	MDS-150AAS12
Output Voltage		12V	12V	12V	12V	12V
Output Current (Max)		2.0A	5.0A	5.0A	6.67A	10.0A
Output Power		24W	60W	60W	80W	120W
Load Regulation		± 5%	± 4.5%	± 5%	± 4.5%	
Ripple & Noise		< 150mV pk-pk @ Rated load	67mV pk-pk @ Full load	1% typ. pk-pk @ Full load	118.4mV pk-pk @ Full load	104mV pk-pk @ Full load
INPUT						
Input Voltage Range		85-264Vac	90-275Vac	90-264Vac		
Input Frequency		47-63Hz				
Average Efficiency	115Vac 230Vac	86.21%	87.0%	88.0%	83% typ.	88.0% 87.0%
Touch Current ¹⁾	264Vac	< 0.1mA @ NC, < 0.3mA @ SFC	-	< 0.1mA @ NC, < 0.3mA @ SFC	< 0.1mA @ NC, < 0.3mA @ SFC	< 0.1mA @ NC, < 0.3mA @ SFC
	275Vac	-	< 0.1mA @ NC, < 0.3mA @ SFC	-	-	-
Leakage Current ¹⁾	264Vac	< 0.1mA @ NC, < 0.5mA @ SFC	-	-	-	-
	275Vac	-	< 0.1mA @ NC, < 0.3mA @ SFC	-	-	-
MECHANICAL						
Dimensions (L × W × H)	mm	88 × 53.5 × 27.5	135 × 62 × 34.1	135 × 62 × 34.1	150 × 75 × 40	170 × 85 × 40
	inch	3.46 × 2.11 × 1.08	5.31 × 2.44 × 1.34	5.31 × 2.44 × 1.34	5.91 × 2.95 × 1.57	6.69 × 3.35 × 1.57
Unit Weight	kg	0.15	0.36	0.34	0.50	1.10
	lb	0.33	0.79	0.78	1.10	2.43
Connector Type		MDS-030AAC12: Input: Wall mount-CN/US/EU/UK/AU/KR/IN/AR/BZ/SA; Output: Barrel type/Tuning fork type MDS-060AAS12: Input: C14 socket; Output: 4-pin DIN/Barrel type/Tuning fork type MDS-060BAS12, MDS-080AAS12: Input: C8 socket; Output: 4-pin DIN/Barrel type/Tuning fork type MDS-150AAS12: Input: C14 socket; Output: 4-pin DIN/Barrel type/Tuning fork type (Select the appropriate DC plug according to the current)				
MTBF ²⁾		500,000 hrs	1,000,000 hrs	1,000,000 hrs	1,000,000 hrs	1,000,000 hrs
EMC & Emissions		EN 55011/EN 55032, FCC Title 47: Class B				
ENVIRONMENT						
Operating Temperature ³⁾		0°C to +40°C				
Storage Temperature		-40°C to +85°C				
Operating Humidity		5 to 95% RH (Non-Condensing)	10 to 95% RH (Non-Condensing)	5 to 95% RH (Non-Condensing)	10 to 95% RH (Non-Condensing)	
Operating Altitude		0 to 5,000 m (0 to 16,400 ft)	0 to 3,000 m (0 to 9,840 ft)	0 to 5,000 m (0 to 16,400 ft)		0 to 3,000 m (0 to 9,840 ft)
Degree of Protection		IP22	-	IP22		-
Protection Against Shock		Class II	Class I	Class II		Class I for F series, Class II with functional earth for B series
MEDICAL RATING						
Float Rating		BF				B
MOPP		2 × MOPP				

Dimensions Reference

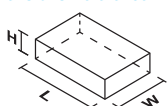

Notes

- 1) NC: normal condition, SFC: single fault condition.
- 2) MTBF as per Telcordia SR-332.
For MDS-030AAC12, MTBF as per Telcordia SR-332 (I/P: 100Vac, O/P: 100% load, Ta: 25°C).
- 3) Refer power de-rating in the product datasheet.

MDS

Features

- Universal AC input voltage range
- Over-Voltage/Load/Temperature & Short Circuit Protections
- Low touch current (< 0.1mA Normal & < 0.3mA Single Fault)
- Compliant with IEC 60601-1-2 Ed. 4 requirements
- Safety approvals for medical and IT applications
- 2 × MOPP isolation



Specifications

OUTPUT		MDS-030AAC15	MDS-060AAS15	MDS-090AAS15
Output Voltage		15V	15V	15V
Output Current (Max)		2.0A	4.0A	6.0A
Output Power		30W	60W	90W
Load Regulation		± 5%		± 4.5%
Ripple & Noise		< 200mV pk-pk @ Rated load	61mV pk-pk @ Full load	114mV pk-pk @ Full load
INPUT				
Input Voltage Range		85-264Vac	90-275Vac	90-264Vac
Input Frequency		47-63Hz		
Average Efficiency	115Vac 230Vac	87.0%	88.0%	88.0%
Touch Current ¹⁾	264Vac	< 0.1mA @ NC, < 0.3mA @ SFC	-	< 0.1mA @ NC, < 0.3mA @ SFC
	275Vac	-	< 0.1mA @ NC, < 0.3mA @ SFC	-
Leakage Current ¹⁾	264Vac	< 0.1mA @ NC, < 0.5mA @ SFC	-	< 0.1mA @ NC, < 0.3mA @ SFC
	275Vac	-	< 0.1mA @ NC, < 0.3mA @ SFC	-
MECHANICAL				
Dimensions (L × W × H)	mm	88 × 53.5 × 27.5	135 × 62 × 34.1	150 × 60 × 35
	inch	3.46 × 2.11 × 1.08	5.31 × 2.44 × 1.34	5.91 × 2.36 × 1.38
Unit Weight	kg	0.15	0.36	0.45
	lb	0.33	0.79	0.99
Connector Type		MDS-030AAC15: Input: Wall mount-CN/US/EU/UK/AU/KR/IN/AR/BZ/SA; Output: Barrel type/Tuning fork type MDS-060AAS15, MDS-090AAS15: Input: C14 socket; Output: 4-pin DIN/Barrel type/Tuning fork type		
MTBF ²⁾		500,000 hrs	1,000,000 hrs	1,000,000 hrs
EMC & Emissions		EN 55011/EN 55032, FCC Title 47: Class B		
ENVIRONMENT				
Operating Temperature ³⁾		0°C to +40°C		
Storage Temperature		-40°C to +85°C		
Operating Humidity		5 to 95% RH (Non-Condensing)	10 to 95% RH (Non-Condensing)	
Operating Altitude		0 to 5,000 m (0 to 16,400 ft)	0 to 3,000 m (0 to 9,840 ft)	
Degree of Protection		IP22	-	
Protection Against Shock		Class II	Class I	Class I for F series Class II with functional earth for B series
MEDICAL RATING				
Float Rating		BF		B
MOPP		2 × MOPP		

Dimensions Reference

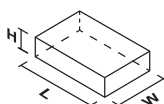

Notes

- 1) NC: normal condition, SFC: single fault condition.
- 2) MTBF as per Telcordia SR-332.
For MDS-030AAC15, MTBF as per Telcordia SR-332 (I/P: 100Vac, O/P: 100% load, Ta: 25°C).
- 3) Refer power de-rating in the product datasheet.

MDS

Features

- Over-Voltage/Load/Temperature & Short Circuit Protections
- Low touch current (< 0.1mA Normal & < 0.3mA Single Fault)
- Compliant with IEC 60601-1-2 Ed. 4 requirements
- Safety approvals for medical and IT applications
- 2 × MOPP isolation
- High MTBF



Specifications

OUTPUT	MDS-060AAS19	MDS-060BAS19	MDS-090AAS19	MDS-150AAS19	MDS-150CAB19	
Output Voltage	19V	19V	19V	19V	19V	
Output Current (Max)	3.15A	3.15A	4.73A	7.89A	7.9A	
Output Power	60W	60W	90W	150W	150W	
Load Regulation	± 4.5%	± 5%		± 4.5%	± 5%	
Ripple & Noise	61mV pk-pk @ Full load	1% typ. pk-pk @ Full load	91.2mV pk-pk @ Full load	94.4mV pk-pk @ Full load	109mV pk-pk @ Full load	
INPUT						
Input Voltage Range	90-275Vac	90-264Vac		90-264Vac		
Input Frequency			47-63Hz			
Average Efficiency	115Vac 230Vac	88.0%	88.0%	88.0%	92.0% typ.	
Touch Current ¹⁾	264Vac	-	< 0.1mA @ NC, < 0.3mA @ SFC	< 0.1mA @ NC, < 0.3mA @ SFC	< 0.1mA @ NC, < 0.3mA @ SFC	
	275Vac	< 0.1mA @ NC, < 0.3mA @ SFC	-	-	-	
Leakage Current ¹⁾	264Vac	-	< 0.1mA @ NC, < 0.3mA @ SFC	< 0.1mA @ NC, < 0.3mA @ SFC	< 0.1mA @ NC, < 0.3mA @ SFC	
	275Vac	< 0.1mA @ NC, < 0.3mA @ SFC	-	-	-	
MECHANICAL						
Dimensions (L × W × H)	mm	135 × 62 × 34.1	135 × 62 × 34.1	150 × 60 × 35	170 × 85 × 40	150 × 65 × 32
	inch	5.31 × 2.44 × 1.34	5.31 × 2.44 × 1.34	5.91 × 2.36 × 1.38	6.69 × 3.35 × 1.57	5.91 × 2.56 × 1.26
Unit Weight	kg	0.36	0.34	0.45	1.10	0.52
	lb	0.79	0.75	0.99	2.43	1.15
Connector Type	MDS-060AAS19, MDS-090AAS19: Input: C14 socket; Output: 4-pin DIN/Barrel type/Tuning fork type MDS-060BAS19: Input: C8 socket; Output: 4-pin DIN/Barrel type/Tuning fork type MDS-150AAS19: Input: C14 socket; Output: 4-pin DIN/Barrel type/Tuning fork type (Select the appropriate DC plug according to the current) MDS-150CAB19: Input: C6 socket; Output: 4-pin DIN/Tuning fork type					
MTBF ²⁾	1,000,000 hrs	1,000,000 hrs	1,000,000 hrs	1,000,000 hrs	2,100,000 hrs	
EMC & Emissions	EN 55011/EN 55032, FCC Title 47: Class B					
ENVIRONMENT						
Operating Temperature ³⁾	0°C to +40°C					
Storage Temperature	-40°C to +85°C					
Operating Humidity	10 to 95% RH (Non-Condensing)	5 to 95% RH (Non-Condensing)	10 to 95% RH (Non-Condensing)			
Operating Altitude	0 to 3,000 m (0 to 9,840 ft)	0 to 5,000 m (0 to 16,400 ft)	0 to 3,000 m (0 to 9,840 ft)		0 to 5,000 m (0 to 16,400 ft)	
Degree of Protection	-	IP22	-		IP22	
Protection Against Shock	Class I	Class II	Class I for F series, Class II with functional earth for B series		Class I	
MEDICAL RATING						
Float Rating	BF		B			
MOPP	2 × MOPP					

Dimensions Reference

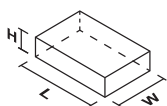

Notes

- 1) NC: normal condition, SFC: single fault condition.
- 2) MTBF as per Telcordia SR-332.
- 3) Refer power de-rating in the product datasheet.

MDS

Features

- Universal AC input voltage range
- Over-Voltage/Load/Temperature & Short Circuit Protections
- Low touch current (< 0.1mA Normal & < 0.3mA Single Fault)
- Compliant with IEC 60601-1-2 Ed. 4 requirements
- Safety approvals for medical and IT applications
- 2 × MOPP isolation
- High MTBF



Specifications

OUTPUT		MDS-030AAC24	MDS-060AAS24	MDS-060BAS24
Output Voltage		24V	24V	24V
Output Current (Max)		1.25A	2.5A	2.5A
Output Power		30W	60W	60W
Load Regulation		± 5%	± 4.5%	± 5%
Ripple & Noise		< 200mV pk-pk @ Rated load	43mV pk-pk @ Full load	1% typ. pk-pk @ Full load
INPUT				
Input Voltage Range		85-264Vac	90-275Vac	90-264Vac
Input Frequency		47-63Hz		
Average Efficiency	115Vac	87.0%	88.0%	87.0%
	230Vac		87.0%	
Touch Current ¹⁾	264Vac	< 0.1mA @ NC, < 0.3mA @ SFC	-	< 0.1mA @ NC, < 0.3mA @ SFC
	275Vac	-	< 0.1mA @ NC, < 0.3mA @ SFC	-
Leakage Current ¹⁾	264Vac	< 0.1mA @ NC, < 0.5mA @ SFC	-	-
	275Vac	-	< 0.1mA @ NC, < 0.3mA @ SFC	-
MECHANICAL				
Dimensions (L × W × H)	mm	88 × 53.5 × 27.5	135 × 62 × 34.1	135 × 62 × 34.1
	inch	3.46 × 2.11 × 1.08	5.31 × 2.44 × 1.34	5.31 × 2.44 × 1.34
Unit Weight	kg	0.15	0.36	0.34
	lb	0.33	0.79	0.75
Connector Type		MDS-030AAC24: Input: Wall mount-CN/US/EU/UK/AU/KR/IN/AR/BZ/SA; Output: Barrel type/Tuning fork type MDS-060AAS24: Input: C14 socket; Output: 4-pin DIN/Barrel type/Tuning fork type MDS-060BAS24: Input: C8 socket; Output: 4-pin DIN/Barrel type/Tuning fork type		
MTBF ²⁾		500,000 hrs	1,000,000 hrs	1,000,000 hrs
EMC & Emissions		EN 55011/EN 55032, FCC Title 47: Class B		
ENVIRONMENT				
Operating Temperature ³⁾		0°C to +40°C		
Storage Temperature		-40°C to +85°C		
Operating Humidity		5 to 95% RH (Non-Condensing)	10 to 95% RH (Non-Condensing)	5 to 95% RH (Non-Condensing)
Operating Altitude		0 to 5,000 m (0 to 16,400 ft)	0 to 3,000 m (0 to 9,840 ft)	0 to 5,000 m (0 to 16,400 ft)
Degree of Protection		IP22	-	IP22
Protection Against Shock		Class II	Class I	Class II
MEDICAL RATING				
Float Rating		BF		
MOPP		2 × MOPP		

Dimensions Reference

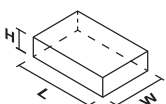

Notes

- 1) NC: normal condition, SFC: single fault condition.
- 2) MTBF as per Telcordia SR-332.
For MDS-030AAC24, MTBF as per Telcordia SR-332 (I/P: 100Vac, O/P: 100% load, Ta: 25°C).
- 3) Refer power de-rating in the product datasheet.

MDS

Features

- Universal AC input voltage range
- Over-Voltage/Load/Temperature & Short Circuit Protections
- Low touch current (< 0.1mA Normal & < 0.3mA Single Fault)
- Compliant with IEC 60601-1-2 Ed. 4 requirements
- Safety approvals for medical and IT applications
- 2 × MOPP isolation
- High MTBF



Specifications

OUTPUT		MDS-090AAS24	MDS-090BAS24	MDS-150AAS24
Output Voltage		24V	24V	24V
Output Current (Max)		3.75A	3.75A	6.25A
Output Power		90W	90W	150W
Load Regulation		± 4.5%		
Ripple & Noise		94.4mV pk-pk @ Full load	107.2mV pk-pk @ Full load	83.2mV pk-pk @ Full load
INPUT				
Input Voltage Range		90-264Vac		
Input Frequency		47-63Hz		
Average Efficiency	115Vac	88.0%	87.61% @ Full load	88.0%
	230Vac	-		87.0%
Touch Current ¹⁾	264Vac	< 0.1mA @ NC, < 0.3mA @ SFC	< 0.1mA @ NC, < 0.3mA @ SFC	< 0.1mA @ NC, < 0.3mA @ SFC
Leakage Current ¹⁾	264Vac	< 0.1mA @ NC, < 0.3mA @ SFC	-	-
MECHANICAL				
Dimensions (L × W × H)	mm	150 × 60 × 35	150 × 75 × 40	170 × 85 × 40
	inch	5.91 × 2.36 × 1.38	5.91 × 2.95 × 1.57	6.69 × 3.35 × 1.57
Unit Weight	kg	0.45	0.50	1.10
	lb	0.99	1.10	2.43
Connector Type		MDS-090AAS24: Input: C14 socket; Output: 4-pin DIN/Barrel type/Tuning fork type MDS-090BAS24: Input: C8 socket; Output: 4-pin DIN/Barrel type/Tuning fork type MDS-150AAS24: Input: C14 socket; Output: 4-pin DIN/Barrel type/Tuning fork type (Select the appropriate DC plug according to the current)		
MTBF ²⁾		1,000,000 hrs	1,000,000 hrs	1,000,000 hrs
EMC & Emissions		EN 55011/EN 55032, FCC Title 47: Class B		
ENVIRONMENT				
Operating Temperature ³⁾		0°C to +40°C		
Storage Temperature		-40°C to +85°C		
Operating Humidity		10 to 95% RH (Non-Condensing)		
Operating Altitude		0 to 3,000 m (0 to 9,840 ft)	0 to 5,000 m (0 to 16,400 ft)	0 to 3,000 m (0 to 9,840 ft)
Degree of Protection		-	IP22	-
Protection Against Shock		Class I for F series, Class II with functional earth for B series	Class II	Class I for F series, Class II with functional earth for B series
MEDICAL RATING				
Float Rating		B	BF	B
MOPP		2 × MOPP		

Dimensions Reference

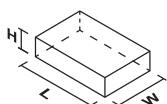

Notes

- 1) NC: normal condition, SFC: single fault condition.
- 2) MTBF as per Telcordia SR-332.
- 3) Refer power de-rating in the product datasheet.

12V, 15V, 24V Output

MEA

Features

- Universal AC input voltage range
- High Efficiency meet DoE VI
- Low leakage current
- 2 × MOPP isolation
- Compliant with IEC 60601-1-2 Ed. 4 requirements
- Safety approvals for medical and IT applications



Specifications

		NEW		NEW	
OUTPUT		MEA-065A12C	MEA-120A15B	MEA-065A24C	MEA-250A24C
Output Voltage		12V	15V	24V	24V
Output Current (Max)		5.0A	8.0A	2.71A	10.42A
Output Power		60W	120W	65W	250W
Load Regulation		± 4.5%	± 5%	± 4.5%	± 4.5%
Ripple & Noise		1%	< 250mV pk-pk	1%	< 240mVpk-pk
INPUT					
Input Voltage Range		90-264Vac			
Input Frequency		47-63Hz			
Average Efficiency	115Vac	88.0%	88.0%	89.0%	90.0%
	230Vac				
Touch Current ¹⁾	264Vac	< 0.1mA @ NC, < 0.3mA @ SFC	< 0.1mA @ NC, < 0.3mA @ SFC	< 0.1mA @ NC, < 0.3mA @ SFC	< 0.1mA @ NC, < 0.3mA @ SFC
Leakage Current ¹⁾	264Vac	< 0.2mA @ NC, < 0.5mA @ SFC	< 0.1mA @ NC, < 0.3mA @ SFC	< 0.2mA @ NC, < 0.5mA @ SFC	< 0.2mA @ NC, < 0.5mA @ SFC
MECHANICAL					
Dimensions (L × W × H)	mm	115 × 50 × 29	170 × 85 × 40	115 × 50 × 29	200 × 100 × 43
	inch	4.53 × 1.97 × 1.14	6.69 × 3.35 × 1.57	4.53 × 1.97 × 1.14	7.87 × 3.94 × 1.69
Unit Weight	kg	0.25	0.74	0.25	1.05
	lb	0.55	1.63	0.55	2.31
Connector Type		MEA-065A12C, MEA-065A24C: Input: C14 socket; Output: Barrel type MEA-120A15B: Input: C8 socket; Output: 4-pin DIN MEA-250A24C: Input: C14 socket; Output: 6-pin mini-fit			
MTBF ²⁾		1,000,000 hrs	1,000,000 hrs	1,000,000 hrs	500,000 hrs
EMC & Emissions		EN 55011/EN 55032, FCC Title 47: Class B	EN 55011/EN 55032	EN 55011/EN 55032, FCC Title 47: Class B	
ENVIRONMENT					
Operating Temperature ³⁾		-10°C to +60°C	0°C to +40°C	-10°C to +60°C	5°C to +60°C
Storage Temperature		-40°C to +85°C			-40°C to +70°C
Operating Humidity		5 to 95% RH (Non-Condensing)			
Operating Altitude		0 to 5,000 m (0 to 16,400 ft)			
Degree of Protection		IP22	IP20		IP22
Protection Against Shock		Class I	Class II		Class I
MEDICAL RATING					
Float Rating		B			BF
MOPP		2 × MOPP			

Dimensions Reference

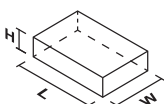

Notes

- 1) NC: normal condition, SFC: single fault condition.
- 2) MTBF as per Telcordia SR-332.
For MEA-250A24C, MTBF as per Telcordia SR-332 (I/P: 115Vac, O/P: 100% load, Ta: 25°C).
- 3) Refer power de-rating in the product datasheet.

MEF

Features

- Safety approvals for medical and IT applications
- Compliant with IEC 60601-1-2 Ed. 4 requirements
- Meets Limited Power Source (LPS) requirements
- IP22 ingress protection rating
- 500K hours MTBF
- 2 × MOPP isolation



Specifications

OUTPUT		MEF-010A05B
Output Voltage		5V
Output Current (Max)		2.0A
Output Power		10W
Load Regulation		± 8%
Ripple & Noise		100mV pk-pk
INPUT		
Input Voltage Range		85-264Vac
Input Frequency		47-63Hz
Efficiency		73.4% typ.
Leakage Current		< 0.1mA
MECHANICAL		
Dimensions (L × W × H)	mm	70 × 43 × 27.5
	inch	2.76 × 1.69 × 1.08
Unit Weight	kg	0.95
	lb	2.09
Connector Type	Input: Wall mount - US Type; Output: Barrel type	
MTBF ¹⁾	500,000 hrs	
EMC & Emissions	EN 55011 / EN 55032, FCC Title 47: Class B	
ENVIRONMENT		
Operating Temperature ³⁾	0°C to +40°C	
Storage Temperature	-40°C to +85°C	
Operating Humidity	10 to 95% RH (Non-Condensing)	
Operating Altitude	0 to 5,000 m (0 to 16,400 ft)	
Degree of Protection	IP22	
Protection Against Shock	Class II	
MEDICAL RATING		
Float Rating	B	
MOPP	2 × MOPP	

Dimensions Reference

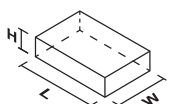

Notes

- 1) MTBF as per Telcordia SR-332.
- 2) Refer power de-rating in the product datasheet.

ACCESSORIES

| DIN Rail Accessories

• L-01

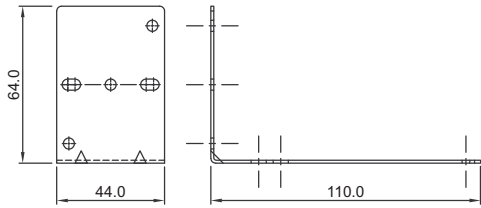

• P-03

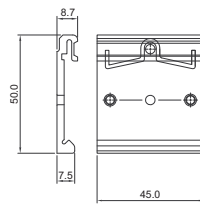

• L-02

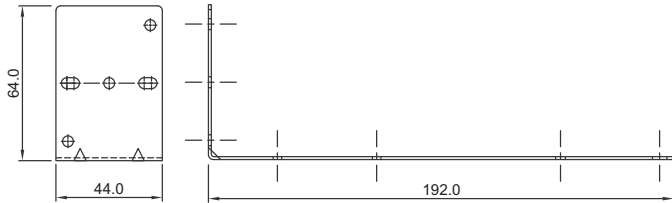

• L-03A

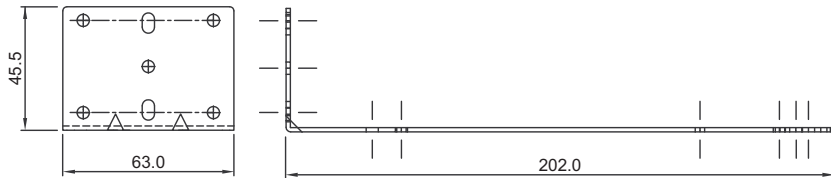

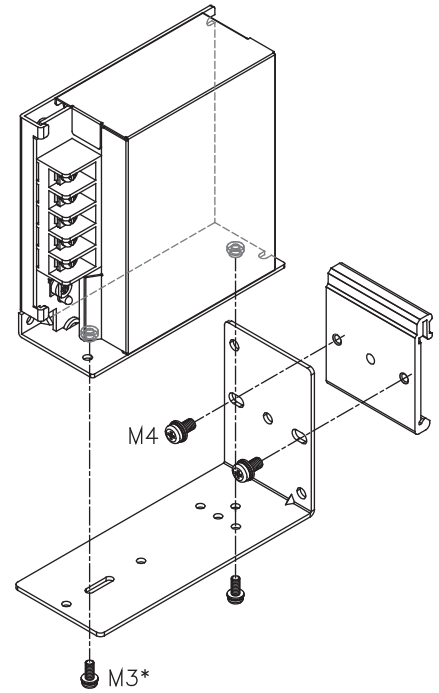

Accessories Assembly

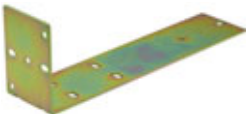

*Except PMC-24V300W1BA. Please use M4 screws only.

Model Information

Item	Model Number	Compatible Models
	L-01	PMC-05V015W1AA, PMC-05V035W1AA, PMC-05V050W1AA PMC-12V035W1AA, PMC-12V050W1AA, PMC-12V060W1AA PMC-24V035W1A□, PMC-24V050W1A□, PMC-24V075W1A□ PMH-12V100WCL□, PMH-12V100WCM□ PMH-24V50WCA□, PMH-24V100WCL□, PMH-24V100WCM□ PMT-5V35W1A□, PML-5V35W1A□, PMT-5V50W1A□, PML-5V50W1A□ PMT-15V50W1A□, PML-15V50W1A□ PMT-12V35W1A□, PML-12V35W1A□, PMT-12V50W1A□, PML-12V50W1A□ PMT-24V35W1A□, PML-24V35W1A□, PMT-24V50W1A□, PML-24V50W1A□
	L-02	PMC-12V100W1A□, PMC-12V150W1B□ PMC-24V100W1A□, PMC-24V150W1A□, PMC-24V150W1B□, PMC-24V150W2AA, PMC-DSPV100W1A PMC-48V150W1BA PMH-24V100WCA□, PMH-24V100WCC□, PMH-24V100WCN□, PMH-24V150WCB□, PMH-24V150WCD□, PMH-24V150WCL□ PMU-13V155W□□A, PMU-27V155W□□A PMT-12V100W1A□, PML-12V100W1A□, PMT-12V150W1A□, PML-12V150W1A□ PMT-24V100W1A□, PML-24V100W1A□, PMT-24V150W1A□, PML-24V150W1A□ PMT-48V150W1A□, PML-48V150W1A□ PMT-D1V100W1A□, PML-D1V100W1A□, PMT-D2V100W1A□, PML-D2V100W1A□
	L-03A	PMC-24V300W1BA PMF-24V200WC□□, PMF-24V240WC□□
	P-03	All models *P-03 must be used with L-01, L-02 or L-03A

ACCESSORIES

| Panel Mount Accessories

- LM-01

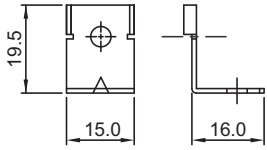

Accessories Assembly

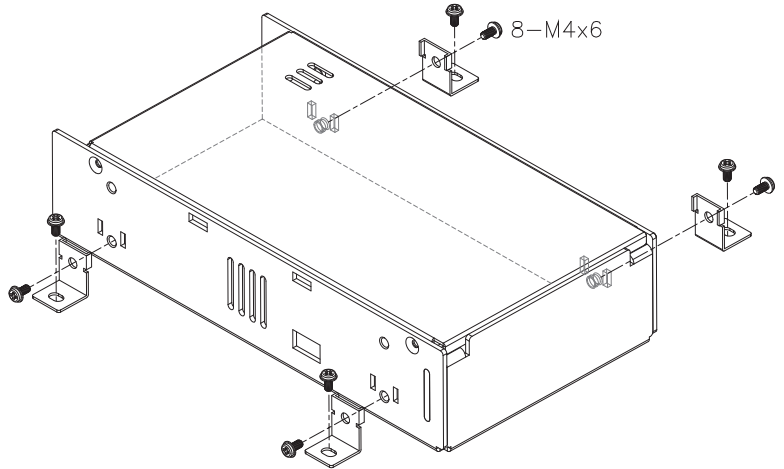

Model Information

Item	Model Number	Compatible Models
	LM-01	PMT-4V350W1A□ PMT-5V350W1A□ PMT-12V350W1A□ PMT-24V200W1A□, PML-24V200W1A□, PMT-24V350W1A□ PMT-36V350W1A□ PMT-48V350W1A□ PMF-4V320WC□□ PMF-5V320WC□□ PMF-24V200WC□□, PMF-24V240WC□□, PMF-24V320WC□□ PMR-4V320WC□A, PMR-4V320WD□A PMR-5V320WC□A, PMR-5V320WD□A

| FAQs



What is Power Boost?

It is the reserve power available constantly that allows reliable startup of loads with high outrush current.



Why is Power Boost beneficial?

Such feature is especially useful for applications where loads are active; the high surge current can cause the power supply unit (PSU) output to dip down if the PSU does not have the capability to withstand this surge current. Consequently, this could reset the system and result in system downtime.



What is Advanced Power Boost (APB)?

Within a multiple loads connection, Advanced Power Boost (APB) can detect a faulty current path and provide a large outrush current to trip the circuit breaker connected to the faulty path. This prevents the system from shutting down while the other connected current paths continue to operate without interruption.



What should I consider when selecting a power supply unit (PSU)?

- Input Type (Single Phase or 3 Phase)
- Output Power
- Efficiency and Reliability

Efficiency and Reliability are the two most important factors to consider in selecting a PSU.

The best way to ensure the reliability of the PSU is to choose one that provides a maximum of 30% more output than your actual total requirement. For example, if your system has a 90W power requirement, you should choose a PSU with at least 120W power output rating. By doing so, you are boosting the reliability of the PSU as well as prolonging the entire system life.

An efficient PSU will thus ensure that power loss is minimized and will greatly help to lower your operating costs in the long run. By choosing a cheaper, but less efficient PSU will just mean that you are paying for it through your monthly electric bills. Delta's CliQ DIN rail power supply easily give our users a substantial efficiency of up to 87% or more even when operating at <100% load. Other factors to consider include the operating conditions, types of safety certifications, PSU protection and application functions. Please contact your nearest Delta sales representative for a recommendation based on your requirements.



What critical parameters do I have to watch out for when connecting the power supplies in series?

The turn ON would be non-monotonic as the power supply with the fastest startup time and rise time will turn on first. As a result, the startup waveform with 2 power supplies connected in series would see a step.

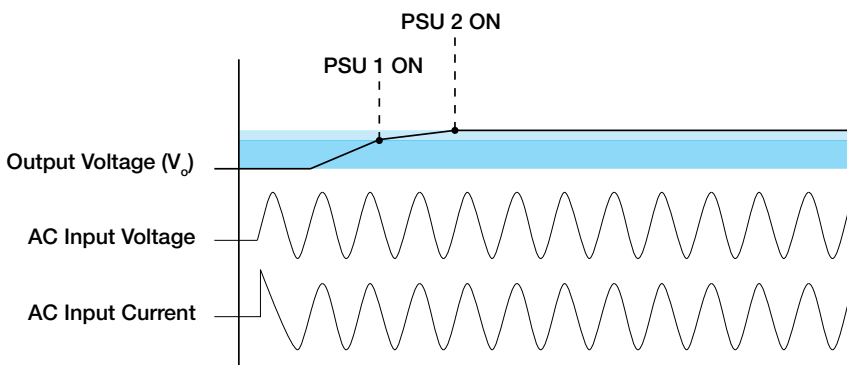

STANDARDS & APPROVALS

| Industrial Power Supplies

	CE	CB Scheme to IEC 60950-1	CB Scheme to IEC 62368-1	SIQ or TUV to EN 60950-1	SIQ or TUV to EN 62368-1	UL 60950-1	UL 62368-1	UL 508	UL 1310	NEC Class 2	CSA C22.2 No. 107.1-01	CSA C22.2 No. 60950-1	ATEX EN 60079-15	CSA C22.2 No. 213 and ANSI/ISA-12.12.09	EAC (Eurasian Customs Union)	CCC (China)	RoHS Directive 2011/65/EU	RoHS Directive (EU) 2015/863 Compliant (EN 50581)	SEMI F47	EN 61204-3	EN 61000-3-2 (PFC)	EN 61000-3-3 (Flicker)	EN 61000-6-1 (Immunity)	EN 61000-6-2 (Immunity)	EN 55024 (Immunity)	EN 55011 Class B (Emissions)	EN 55032 Class B (Emissions)	
DIN Rail Power Supply																												
DRP012V015W1AY	●	●	○	●	○	●	○	●			●		●	●	●		●	●			●	●	●	●	●	●	●	●
DRP012V015W1AZ	●	●	○	●	○	●	○	●			●		●	●	●		●	●			●	●	●	●	●	●	●	●
DRP012V030W1AY	●	●	○	●	○	●	○	●			●		●	●	●		●	●			●	●	●	●	●	●	●	●
DRP012V030W1AZ	●	●	○	●	○	●	○	●			●		●	●	●		●	●			●	●	●	●	●	●	●	●
DRP012V060W1AA	●	●	○	●	○	●	○	●			●		●	●	●		●	●			●	●	●	●	●	●	●	●
DRP012V100W1AA	●	●	○	●	○	●	○	●			●		●	●	●		●	●			●	●	●	●	●	●	●	●
DRP-24V48W1AZ	●	●	○	●	○	●	○	●			●		●	●	●		●	●			●	●	●	●	●	●	●	●
DRP024V060W1AZ	●	●	●	●	●	●	○	●			●	●	●	●	●		●	●			●	●	●	●	●	●	●	●
DRP024V060W1AA	●	●	○	●	○	●	○	●			●	●	●	●	●		●	●	●		●	●	●	●	●	●	●	●
DRP024V120W1AA	●	●	○	●	○	●	○	●			●	●	●	●	●		●	●	●		●	●	●	●	●	●	●	●
DRP024V240W1AA	●	●	○	●	○	●	○	●			●	●	●	●	●		●	●	●		●	●	●	●	●	●	●	●
DRP024V480W1AA	●	●	●	●	●	●	●	●			●	●	●	●	●		●	●			●	●	●	●	●	●	●	●
DRP024V060W1BA	●	●	●	●	●	●	●	●			●	●	●	●	●		●	●			●	●	●	●	●	●	●	●
DRP024V060W1BN	●	●	●	●	●	●	●	●			●	●	●	●	●		●	●			●	●	●	●	●	●	●	●
DRP024V120W1BA	●	●	●	●	●	●	●	●			●	●	●	●	●		●	●			●	●	●	●	●	●	●	●
DRP024V120W1BN	●	●	●	●	●	●	●	●			●	●	●	●	●	●	●	●			●	●	●	●	●	●	●	●
DRP024V240W1BA	●	●	●	●	●	●	●	●			●	●	●	●	●		●	●			●	●	●	●	●	●	●	●
DRP024V240W1BN	●	●	●	●	●	●	●	●			●	●	●	●	●		●	●			●	●	●	●	●	●	●	●
DRP024V480W1BA	●	●	●	●	●	●	●	●			●	●	●	●	●		●	●			●	●	●	●	●	●	●	●
DRP024V480W1BN	●	●	●	●	●	●	●	●			●	●	●	●	●		●	●			●	●	●	●	●	●	●	●
DRP024V060W1NY	●	●	○	●	○	●	○	●	●	●	●	●	●	●	●		●	●			●	●	●	●	●	●	●	●
DRP024V060W1NZ	●	●	○	●	○	●	○	●	●	●	●	●	●	●	●		●	●			●	●	●	●	●	●	●	●
DRP-24V100W1NN	●	●	○	●	○	●	○	●	●	●	●	●	●	●	●		●	●			●	●	●	●	●	●	●	●
DRP-24V120W2BN	●	●	○	●	○	●	○	●			●		●	●	●		●	●			●	●	●	●	●	●	●	●
DRP-24V240W2BN	●	●	○	●	○	●	○	●			●		●	●	●		●	●			●	●	●	●	●	●	●	●
DRP024V060W3BA	●	●	●	●	●	●	●	●			●	●	●	●	●		●	●			●	●	●	●	●	●	●	●
DRP024V060W3BN	●	●	●	●	●	●	●	●			●	●	●	●	●		●	●			●	●	●	●	●	●	●	●
DRP024V120W3BA	●	●	●	●	●	●	●	●			●	●	●	●	●		●	●			●	●	●	●	●	●	●	●
DRP024V120W3BN	●	●	●	●	●	●	●	●			●	●	●	●	●		●	●			●	●	●	●	●	●	●	●
DRP024V240W3BA	●	●	●	●	●	●	●	●			●	●	●	●	●		●	●			●	●	●	●	●	●	●	●
DRP024V240W3BN	●	●	●	●	●	●	●	●			●	●	●	●	●		●	●			●	●	●	●	●	●	●	●
DRP024V480W3BA	●	●	●	●	●	●	●	●			●	●	●	●	●		●	●			●	●	●	●	●	●	●	●
DRP024V480W3BN	●	●	●	●	●	●	●	●			●	●	●	●	●		●	●			●	●	●	●	●	●	●	●
DRP024V960W3BN	●	●	○	●	○	●	○	●			●		●	●	●		●	●			●	●	●	●	●	●	●	●
DRP048V060W1BA	●	●	○	●	○	●	○	●			●		●	●	●		●	●			●	●	●	●	●	●	●	●
DRP048V060W1BN	●	●	○	●	○	●	○	●			●		●	●	●		●	●			●	●	●	●	●	●	●	●
DRP048V120W1BA	●	●	●	●	●	●	●	●			●	●	●	●	●		●	●			●	●	●	●	●	●	●	●
DRP048V120W1BN	●	●	●	●	●	●	●	●			●	●	●	●	●		●	●			●	●	●	●	●	●	●	●
DRP048V240W1BA	●	●	●	●	●	●	●	●			●	●	●	●	●		●	●			●	●	●	●	●	●	●	●
DRP048V240W1BN	●	●	●	●	●	●	●	●			●	●	●	●	●		●	●			●	●	●	●	●	●	●	●
DRP048V480W1BA	●	●	●	●	●	●	●	●			●	●	●	●	●		●	●			●	●	●	●	●	●	●	●
DRP048V480W1BN	●	●	●	●	●	●	●	●			●	●	●	●	●		●	●			●	●	●	●	●	●	●	●

Please visit www.DeltaPSU.com to check the certification status.

● Certified
○ Pending
IEC/EN/UL 62368-1 implementation date is within December 2020.

DIN Rail Power Supply		CE	CB Scheme to IEC 60950-1	CB Scheme to IEC 62368-1	CB Scheme to IEC 61558-1, IEC 61558-2-16	CB Scheme to IEC 61010-1	CB Scheme to IEC 60335-1	SIQ or TUV to EN 60950-1	SIQ or TUV to EN 62368-1	SIQ to EN 61558-1, EN 61558-2-16	SIQ to EN 61010-1	TUV to EN 60335-1	UL 60950-1	UL 62368-1	UL 508	NEC Class 2	CSA C22.2 No. 107.1-01	EAC (Eurasian Customs Union)	CCC (China)	KC (Korea)	DNV GL (Maritime)	ABS	RoHS Directive 2011/65/EU	RoHS Directive (EU) 2015/863 Compliant (EN 50581)	SEMI F47	EN 61204-3	EN 61000-3-2 (PFC)	EN 61000-3-3 (Flicker)	EN 61000-6-1 (Immunity)	EN 61000-6-2 (Immunity)	EN 5014-2 (Immunity)	EN 55024 (Immunity)	EN 55011 Class B (Emissions)	EN 55014-1 (Emissions)	EN 55032 Class A (Emissions)	EN 55032 Class B (Emissions)	EN 61000-6-3 (Emissions)	EN 61000-6-4 (Emissions)	FCC Part 15 Class B (Emissions)								
DRP-24V120W1C□N	●	●	○					●	○				●	○	●				●				●	●	△	●	●	●	●	●	●	●	●							●							
DRP-24V240W1C□N	●	●	○					●	○				●	○	●				●				●	●	△	●	●	●	●	●	●	●	●	●	●							●					
DRP-24V480W1C□N	●	●	○					●	○				●	○	●				●				●	●	△	●	●	●	●	●	●	●	●	●	●	●							●				
DRM-24V80W1PN	●	●	○	●	●			●	○	●	●		●	○	●			●	●		●	●	●	△	●	●	●	●	●	●	●	●	●	●	●	●							●	●			
DRM-24V120W1PN	●	●	○	●	●			●	○	●	●		●	○	●			●	●		●	●	●	△	●	●	●	●	●	●	●	●	●	●	●	●	●							●	●		
DRM-24V240W1PN	●	●	○	●	●			●	○	●	●		●	○	●			●	●		●	●	●	△	●	●	●	●	●	●	●	●	●	●	●	●	●							●	●		
DRM-24V480W1PN	●	●	○	●	●			●	○	●	●		●	○	●			●	●		●	●	●	△	●	●	●	●	●	●	●	●	●	●	●	●	●							●	●		
DRM-24V960W1PN	●	●	○	●	●			●	○	●	●		●	○	●			●	●		●	●	●	△	●	●	●	●	●	●	●	●	●	●	●	●	●							●	●		
DRM-24V480W1SN	●	●	●	●				●	●				●	●	●				●			●	○	△	●	●	●	●	●	●	●	●	●	●	●	●								●	●	●	
DRM-24V480W3PN	●	●	●	●	●			●	●				●	●	●				●			●	●	△	●	●	●	●	●	●	●	●	●	●	●	●	●							●	●	●	
DRM-24V960W3PN	●	●	●	●	●			●	●				●	●	●				●			●	●	△	●	●	●	●	●	●	●	●	●	●	●	●	●							●	●	●	
DRV-24V120W1PN	●	●	○					●	○	●	●		●	○	●			●	●		●	●	●	△	●	●	●	●	●	●	●	●	●	●	●	●	●							●	●		
DRV-24V240W1PN	●	●	○					●	○	●	●		●	○	●			●	●		●	●	●	△	●	●	●	●	●	●	●	●	●	●	●	●	●							●	●		
DRV-24V480W1PN	●	●	○	●	●			●	○	●	●		●	○	●			●	●		●	●	●	△	●	●	●	●	●	●	●	●	●	●	●	●	●							●	●		
DRL-12V75W1AZ	○	○	○						○					○		○			○	○	○	○	○	○	○	○	○	○	○	○	○	○	○	○	○	○	○							○	○		
DRL-24V75W1AZ	○	○	○						○					○		○			○	○	○	○	○	○	○	○	○	○	○	○	○	○	○	○	○	○	○							○	○		
DRL-24V120W1A□	●	●						●					●	●	●				●			●	●	△	●	●	●	●	●	●	●	●	●	●	●	●								●	●	●	
DRL-24V240W1A□	●	●						●					●	●	●				●			●	●	△	●	●	●	●	●	●	●	●	●	●	●	●								●	●	●	
DRL-24V480W1A□	●	●						●					●	●	●				●			●	●	△	●	●	●	●	●	●	●	●	●	●	●	●								●	●	●	
DRL-48V75W1AZ	○	○	○						○					○		○			○	○	○	○	○	○	○	○	○	○	○	○	○	○	○	○	○	○	○								○	○	
DRL-48V120W1A□	●	●						●					●	●	●				●			●	●	△	●	●	●	●	●	●	●	●	●	●	●	●								●	●	●	
DRC-5V10W1A□	●	●						●					●	●	●				●			●	●	●	●	●	●	●	●	●	●	●	●	●	●	●								●	●		
DRC-12V10W1A□	●	●						●					●	●	●				●			●	●	●	●	●	●	●	●	●	●	●	●	●	●	●								●	●		
DRC-12V30W1A□	●	●						●					●	●	●				●			●	●	●	●	●	●	●	●	●	●	●	●	●	●	●								●	●		
DRC-12V60W1A□	●	●						●					●	●	●				●			●	●	●	●	●	●	●	●	●	●	●	●	●	●	●								●	●		
DRC-12V60W1C□	●	●	●					●					●	●	●				●			●	●	●	●	●	●	●	●	●	●	●	●	●	●	●								●	●		
DRC-12V100W1AZ	●	●						●					●	●	●				●			●	●	●	●	●	●	●	●	●	●	●	●	●	●	●								●	●		
DRC-24V10W1A□	●	●						●					●	●	●				●			●	●	●	●	●	●	●	●	●	●	●	●	●	●	●								●	●		
DRC-24V10W1HZ	●	●				●		●				●	●	●					●			●	●	●	●	●	●	●	●	●	●	●	●	●	●	●								●	●		
DRC-24V30W1A□	●	●						●					●	●	●				●			●	●	●	●	●	●	●	●	●	●	●	●	●	●	●								●	●		
DRC-24V60W1A□	●	●						●					●	●	●				●			●	●	●	●	●	●	●	●	●	●	●	●	●	●	●								●	●		
DRC-24V100W1A□	●	●						●					●	●	●				●			●	●	●	●	●	●	●	●	●	●	●	●	●	●	●								●	●		
DRS-5V30W1NZ	●	●	●					●	●				●	●	●				●			●	●	●	●	●	●	●	●	●	●	●	●	●	●	●								●	●	●	
DRS-5V50W1A□	●	●	●					●	●				●	●	●				●			●	●	●	●	●	●	●	●	●	●	●	●	●	●	●								●	●	●	
DRS-5V50W1N□	●	●	●					●	●				●	●	●				●			●	●	●	●	●	●	●	●	●	●	●	●	●	●	●								●	●	●	
DRS-12V50W1N□	●	●	●					●	●				●	●	●				●			●	●	●	●	●	●	●	●	●	●	●	●	●	●	●								●	●	●	
DRS-24V30W1AZ	●	●						●					●	●	●				●			●	●	●	●	●	●	●	●	●	●	●	●	●	●	●								●	●		
DRS-24V30W1NZ	●	●	●					●	●				●	●	●				●			●	●	●	●	●	●	●	●	●	●	●	●	●	●	●								●	●	●	
DRS-24V50W1N□	●	●	●					●	●				●	●	●				●			●	●	●	●	●	●	●	●	●	●	●	●	●	●	●								●	●	●	
DRS-24V100W1A□	●	●	●					●	●				●	●	●				●			●	●	●	●	●	●	●	●	●	●	●	●	●	●	●								●	●	●	
DRS-24V100W1N□	●	●	●					●	●				●	●	●				●			●	●	●	●	●	●	●	●	●	●	●	●	●	●	●								●	●	●	

Please visit www.DeltaPSU.com to check the certification status.

- Certified
- Pending
- △ Compliant

IEC/EN/UL 62368-1 implementation date is within December 2020.

STANDARDS & APPROVALS

| Industrial Power Supplies

	CE	CB Scheme to IEC 60950-1	CB Scheme to IEC 62368-1	CB Scheme to IEC 61558-1, IEC 61558-2-16	CB Scheme to IEC 60335-1	TUV to EN 60950-1	TUV to EN 62368-1	TUV to EN 61558-1, EN 61558-2-16	TUV to EN 60335-1	UL 60950-1	UL 62368-1	EAC (Eurasian Customs Union)	CCC (China)	KC (Korea)	RoHS Directive 2011/65/EU	RoHS Directive (EU) 2015/863 Compliant (EN 50581)	EN 61000-3-2 (PFC)	EN 61000-3-3 (Flicker)	EN 61000-6-1 (Immunity)	EN 61000-6-2 (Immunity)	EN 55014-2 (Immunity)	EN 55024 (Immunity)	EN 55011 Class B (Emissions)	EN 55032 Class A (Emissions)	EN 55032 Class B (Emissions)	EN 55014-1 (Emissions)	EN 61000-6-3 (Emissions)	
Panel Mount Power Supply																												
PMT-4V350W1A□		•								•					•	•												
PML-5V35W1A□	•	•				•				•			•		•	•	•	•				•				•		
PMT-5V35W1A□	•	•				•				•			•		•	•	•	•				•				•		
PML-5V50W1A□	•	•								•			•		•	•	•	•				•				•		
PMT-5V50W1A□	•	•				•				•			•		•	•	•	•				•				•		
PMT-5V350W1A□		•								•					•	•												
PMB-12V35W1A□	•	•				•				•			•		•	•	•	•				•				•		
PML-12V35W1A□	•	•				•				•			•		•	•	•	•				•				•		
PMT-12V35W1A□	•	•				•				•			•		•	•	•	•				•				•		
PMB-12V50W1A□	•	•				•				•			•		•	•	•	•				•				•		
PML-12V50W1A□	•	•				•				•			•		•	•	•	•				•				•		
PMT-12V50W1A□	•	•				•				•			•		•	•	•	•				•				•		
PML-12V100W1A□	•	•				•				•			•		•	•	•	•				•				•		
PMT-12V100W1A□	•	•				•				•			•		•	•	•	•				•				•		
PML-12V150W1A□	•	•				•				•			•		•	•	•	•				•				•		
PMT-12V150W1A□	•	•				•				•			•		•	•	•	•				•				•		
PMT-12V350W1A□	•	•				•				•			•		•	•						•				•		
PML-15V50W1A□	•	•				•				•			•		•	•	•	•				•				•		
PMT-15V50W1A□	•	•				•				•			•		•	•	•	•				•				•		
PMB-24V35W1A□	•	•				•				•			•		•	•	•	•				•				•		
PML-24V35W1A□	•	•				•				•			•		•	•	•	•				•				•		
PMT-24V35W1A□	•	•				•				•			•		•	•	•	•				•				•		
PMB-24V50W1A□	•	•				•				•			•		•	•	•	•				•				•		
PML-24V50W1A□	•	•				•				•			•		•	•	•	•				•				•		
PMT-24V50W1A□	•	•				•				•			•		•	•	•	•				•				•		
PML-24V100W1A□	•	•				•				•			•		•	•	•	•				•				•		
PMT-24V100W1A□	•	•				•				•			•		•	•	•	•				•				•		
PML-24V150W1A□	•	•				•				•			•		•	•	•	•				•				•		
PMT-24V150W1A□	•	•				•				•			•		•	•	•	•				•				•		
PML-24V200W1A□		•								•					•	•	•	•				•				•		
PMT-24V200W1A□		•								•					•	•	•	•				•				•		
PMT-24V350W1AG		•								•					•	•	•	•				•				•		
PMT-24V350W1AM		•								•					•	•	•	•				•				•		
PMT-24V350W1AK	•	•				•				•					•	•	•	•				•	•			•		
PMT-24V350W1AR	•	•				•				•					•	•	•	•				•	•			•		
PMT-36V350W1A□	•	•				•				•					•	•	•	•				•				•		
PML-48V150W1A□	•	•				•				•			•		•	•	•	•				•				•		
PMT-48V150W1A□	•	•				•				•			•		•	•	•	•				•				•		
PMT-48V350W1A□	•	•				•				•			•		•	•	•	•				•				•		
PML-D1V100W1A□	•	•				•				•			•		•	•	•	•				•				•		
PMT-D1V100W1A□	•	•				•				•			•		•	•	•	•				•				•		
PML-D2V100W1A□	•	•				•				•			•		•	•	•	•				•				•		
PMT-D2V100W1A□	•	•				•				•			•		•	•	•	•				•				•		

Please visit www.DeltaPSU.com to check the certification status.

• Certified
IEC/EN/UL 62368-1 implementation date is within December 2020.

	CE	CB Scheme to IEC 60950-1	CB Scheme to IEC 62368-1	CB Scheme to IEC 61558-1, IEC 61558-2-16	CB Scheme to IEC 60335-1	TUV to EN 60950-1	TUV to EN 62368-1	TUV to EN 61558-1, EN 61558-2-16	TUV to EN 60335-1	UL 60950-1	UL 62368-1	EAC (Eurasian Customs Union)	CCC (China)	KC (Korea)	RoHS Directive 2011/65/EU	RoHS Directive (EU) 2015/863 Compliant (EN 50581)	EN 61000-3-2 (PFC)	EN 61000-3-3 (Flicker)	EN 61000-6-1 (Immunity)	EN 61000-6-2 (Immunity)	EN 55014-2 (Immunity)	EN 55024 (Immunity)	EN 55011 Class B (Emissions)	EN 55032 Class A (Emissions)	EN 55032 Class B (Emissions)	EN 55014-1 (Emissions)	EN 61000-6-3 (Emissions)		
Panel Mount Power Supply																													
PMT-12V35W2BA□	○	○	○	○	○	○	○	○	○		○	○	○	○	○	○	○			○	○					○			○
PMT-12V50W2BA□	●	●	●	●	●	●	●	●	●		●	●	●	●	●	●	●			●	●					●			●
PMT-12V75W2BA□	○	○	○	○	○	○	○	○	○		○	○	○	○	○	○	○			○	○					○			○
PMT-12V100W2BA□	●	●	●	●	●	●	●	●	●		●	●	●	●	●	●	●			●	●					●			●
PMT-12V150W2BA□	●	●	●	●	●	●	●	●	●		●	●	●	●	●	●	●			●	●					●			●
PMT-12V350W2BM		○	○								○	○			○	○													
PMT-12V350W2BR□	○	○	○			○	○				○	○			○	○					○								○
PMT-15V35W2BA	○	○	○	○	○	○	○	○	○		○	○	○	○	○	○	○			○	○					○			○
PMT-15V50W2BA	○	○	○	○	○	○	○	○	○		○	○	○	○	○	○	○			○	○					○			○
PMT-15V75W2BA	○	○	○	○	○	○	○	○	○		○	○	○	○	○	○	○			○	○					○			○
PMT-15V100W2BA	○	○	○	○	○	○	○	○	○		○	○	○	○	○	○	○			○	○					○			○
PMT-15V150W2BA	○	○	○	○	○	○	○	○	○		○	○	○	○	○	○	○			○	○					○			○
PMT-24V35W2BA□	○	○	○	○	○	○	○	○	○		○	○	○	○	○	○	○			○	○					○			○
PMT-24V50W2BA□	●	●	●	●	●	●	●	●	●		●	●	●	●	●	●	●			●	●					●			●
PMT-24V75W2BA□	○	○	○	○	○	○	○	○	○		○	○	○	○	○	○	○			○	○					○			○
PMT-24V100W2BA□	●	●	●	●	●	●	●	●	●		●	●	●	●	●	●	●			●	●					●			●
PMT-24V150W2BA□	●	●	●	●	●	●	●	●	●		●	●	●	●	●	●	●			●	●					●			●
PMT-24V350W2BM		○	○								○	○			○	○													
PMT-24V350W2BR□	○	○	○			○	○				○	○			○	○					○								○
PMT-30V35W2BA	○	○	○	○	○	○	○	○	○		○	○	○	○	○	○	○			○	○					○			○
PMT-30V50W2BA	○	○	○	○	○	○	○	○	○		○	○	○	○	○	○	○			○	○					○			○
PMT-30V75W2BA	○	○	○	○	○	○	○	○	○		○	○	○	○	○	○	○			○	○					○			○
PMT-30V100W2BA	○	○	○	○	○	○	○	○	○		○	○	○	○	○	○	○			○	○					○			○
PMT-30V150W2BA	○	○	○	○	○	○	○	○	○		○	○	○	○	○	○	○			○	○					○			○
PMT-36V35W2BA	○	○	○	○	○	○	○	○	○		○	○	○	○	○	○	○			○	○					○			○
PMT-36V50W2BA	○	○	○	○	○	○	○	○	○		○	○	○	○	○	○	○			○	○					○			○
PMT-36V75W2BA	○	○	○	○	○	○	○	○	○		○	○	○	○	○	○	○			○	○					○			○
PMT-36V100W2BA	○	○	○	○	○	○	○	○	○		○	○	○	○	○	○	○			○	○					○			○
PMT-36V150W2BA	○	○	○	○	○	○	○	○	○		○	○	○	○	○	○	○			○	○					○			○
PMT-36V350W2BR	○	○	○			○	○				○	○			○	○					○								○
PMT-48V35W2BA	○	○	○	○	○	○	○	○	○		○	○	○	○	○	○	○			○	○					○			○
PMT-48V50W2BA	○	○	○	○	○	○	○	○	○		○	○	○	○	○	○	○			○	○					○			○
PMT-48V75W2BA	○	○	○	○	○	○	○	○	○		○	○	○	○	○	○	○			○	○					○			○
PMT-48V100W2BA	○	○	○	○	○	○	○	○	○		○	○	○	○	○	○	○			○	○					○			○
PMT-48V150W2BA	○	○	○	○	○	○	○	○	○		○	○	○	○	○	○	○			○	○					○			○
PMT-48V350W2BR	○	○	○			○	○				○	○			○	○					○								○
PMT-D1V75W2BA□	○	○	○	○	○	○	○	○	○		○	○	○	○	○	○	○			○	○					○			○
PMT-D2V75W2BA□	○	○	○	○	○	○	○	○	○		○	○	○	○	○	○	○			○	○					○			○

Please visit www.DeltaPSU.com to check the certification status.

- Certified
 - Pending
- IEC/EN/UL 62368-1 implementation date is within December 2020.

STANDARDS & APPROVALS

| Industrial Power Supplies

	CE	CB Scheme to IEC 60950-1	CB Scheme to IEC 62368-1	CB Scheme to IEC 61558-1, IEC 61558-2-16	CB Scheme to IEC 60335-1	SIQ or TUV to EN 60950-1	SIQ to EN 62368-1	SIQ to EN 61558-1, EN 61558-2-16	SIQ to EN 60335-1	UL 60950-1	UL 62368-1	NEC Class 2	EAC (Eurasian Customs Union)	CCC (China)	KC (Korea)	RoHS Directive 2011/65/EU	RoHS Directive (EU) 2015/863 Compliant (EN 50581)	EN 61204-3	EN 61000-3-2 (PFC)	EN 61000-3-3 (Flicker)	EN 61000-6-1 (Immunity)	EN 61000-6-2 (Immunity)	EN 55014-2 (Immunity)	EN 55024 (Immunity)	EN 55011 Class B (Emissions)	EN 55032 Class B (Emissions)	EN 55014-1 (Emissions)	EN 61000-6-3 (Emissions)		
Panel Mount Power Supply																														
PMC-05V015W1AA	●	●	○			●	○			●	○		●	●		●	●		●	●					●		●			
PMC-05V035W1A□	●	●	○			●	○			●	○		●	●		●	●		●	●					●		●			
PMC-05V050W1AA	●	●	○			●	○			●	○		●	●		●	●		●	●					●		●			
PMC-12V035W1A□	●	●	○			●	○			●	○		●	●		●	●		●	●					●		●			
PMC-12V050W1A□	●	●	○			●	○			●	○		●	●		●	●		●	●					●		●			
PMC-12V060W1NA	●	●	○			●	○			●	○	●	●	●		●	●		●	●					●		●			
PMC-12V100W1A□	●	●	○			●	○			●	○		●	●		●	●		●	●					●		●			
PMC-12V150W1B□	●	●	○			●	○			●	○		●	●		●	●		●	●					●		●			
PMC-12V600W1BA	●	●	●			●	●			●	●		●	●		●	●		●	●		●			●	●	●		●	
PMC-24V035W1A□	●	●	●			●	●			●	●		●	●		●	●		●	●					●		●			
PMC-24V050W1A□	●	●	●			●	●			●	●		●	●		●	●		●	●					●		●			
PMC-24V075W1A□	●	●	○			●	○			●	○		●	●		●	●		●	●					●		●			
PMC-24V100W1A□	●	●	●			●	●			●	●		●	●		●	●		●	●					●		●			
PMC-24V150W1A□	●	●	○			●	○			●	○		●	●		●	●		●	●					●		●			
PMC-24V150W2AA	●	●	○			●	○			●	○		●	●		●	●		●	●					●		●			
PMC-24V150W1B□	●	●	●			●	●			●	●		●	●		●	●		●	●					●		●			
PMC-24V300W1BA	●	●	○			●	○			●	○		●	●		●	●		●	●					●		●			
PMC-24V600W1BA	●	●	●			●	●			●	●		●	●		●	●		●	●		●			●	●	●		●	
PMC-DSPV100W1A	●	●	○			●	○			●	○		●	●		●	●		●	●					●		●			
PMC-48V150W1BA	●	●	○			●	○			●	○		●	●		●	●		●	●					●		●			
PMC-48V600W1BA	●	●	●			●	●			●	●		●	●		●	●		●	●					●	●	●		●	
PMH-24V50WCA□	●	●	○	●	●	●	○	●	●	●	○		●	●		●	●		●	●		●			●		●		●	
PMH-24V100WCA□	●	●	○	●	●	●	○	●	●	●	○		●	●		●	●		●	●		●			●		●		●	
PMH-24V100WCC□	●	●	○	●	●	●	○			●	○		●	●		●	●		●	●		●			●		●		●	
PMH-24V100WCN□	●	●	○	●	●	●	○			●	○	●	●	●		●	●		●	●		●			●		●		●	
PMH-24V150WCB□	●	●	○	●	●	●	○	●	●	●	○		●	●		●	●		●	●		●			●		●		●	
PMH-24V150WCD□	●	●	○	●	●	●	○			●	○		●	●		●	●		●	●		●			●		●		●	
PMH-24V200WCB□	●	●	●	●	●	●	●			●	●		●	●		●	●		●	●		●			●		●		●	
PMH-12V100WCL□	●	●	●	●	●	●	●			●	●		●	●		●	●		●	●		●			●		●		●	
PMH-12V100WCM□	●	●	●	●	●	●	●			●	●		●	●		●	●		●	●		●			●		●		●	
PMH-24V100WCL□	●	●	●	●	●	●	●			●	●		●	●		●	●		●	●		●			●		●		●	
PMH-24V100WCM□	●	●	●	●	●	●	●			●	●	●	●	●		●	●		●	●		●			●		●		●	
PMH-24V150WCL□	●	●	○	●	●	●	○			●	○		●	●		●	●		●	●		●			●		●		●	
PMF-4V320WC□□	●	●				●				●				●		●	●		●	●					●		●			
PMF-5V320WC□□	●	●				●				●				●		●	●		●	●					●		●			
PMF-24V200WCA□	●	●				●				●				●		●	●		●	●					●		●			
PMF-24V200WCG□	●	●				●				●				●		●	●		●	●					●		●			
PMF-24V240WCA□	●	●				●				●				●		●	●		●	●					●		●			
PMF-24V240WCG□	●	●				●				●				●		●	●		●	●					●		●			
PMF-24V320WCA□	●	●				●				●				●		●	●		●	●					●		●			
PMF-24V320WCG□	●	●				●				●				●		●	●		●	●					●		●			
PMR-4V320WC□A	●	●				●				●				●		●	●		●	●					●		●			
PMR-4V320WD□A	●	●				●				●				●		●	●		●	●					●		●			
PMR-5V320WC□A	●	●				●				●				●		●	●		●	●					●		●			
PMR-5V320WD□A	●	●				●				●				●		●	●		●	●					●		●			

Please visit www.DeltaPSU.com to check the certification status.

- Certified
 - Pending
- IEC/EN/UL 62368-1 implementation date is within December 2020.

	CE	CB Scheme to IEC 60950-1	CB Scheme to IEC 62368-1	CB Scheme to IEC 61558-1, IEC 61558-2-16	CB Scheme to IEC 60335-1	SIQ or TUV to EN 60950-1	TUV to EN 62368-1	UL 60950-1	UL 62368-1	NEC Class 2	EAC (Eurasian Customs Union)	CCC (China)	KC (Korea)	RoHS Directive 2011/65/EU	RoHS Directive (EU) 2015/863 Compliant (EN 50581)	SEMI F47	EN 61204-3	EN 61000-3-2 (PFC)	EN 61000-3-3 (Flicker)	EN 61000-6-1 (Immunity)	EN 61000-6-2 (Immunity)	EN 55014-2 (Immunity)	EN 55024 (Immunity)	EN 55011 Class B (Emissions)	EN 55032 Class A (Emissions)	EN 55032 Class B (Emissions)	EN 55014-1 (Emissions)	EN 61000-6-3 (Emissions)			
Panel Mount Power Supply																															
PMU-13V155W□□A	●	●	○			●	○	●	○			●		●	●			●	●					●				●			
PMU-27V155W□□A	●	●	○			●	○	●	○			●		●	●			●	●					●				●			
Open Frame Power Supply																															
PJT-12V40WBA□	●	●				●		●						●	●			●	●					●				●			
PJT-12V65WBA□	●	●	●			●		●						●	●			●	●					●				●			
PJT-12V100WBA□	●	●				●		●						●	●			●	●					●				●			
PJT-12V100WBB□	●	●				●		●						●	●			●	●					●				●			
PJT-15V40WBA□	●	●				●		●						●	●			●	●					●				●			
PJT-15V65WBA□	●	●	●			●		●						●	●			●	●					●				●			
PJT-15V100WBA□	●	●				●		●						●	●			●	●					●				●			
PJT-15V100WBB□	●	●				●		●						●	●			●	●					●				●			
PJT-18V40WBA□	●	●				●		●						●	●			●	●					●				●			
PJT-18V65WBA□	●	●	●			●		●						●	●			●	●					●				●			
PJT-18V100WBA□	●	●				●		●						●	●			●	●					●				●			
PJT-18V100WBB□	●	●				●		●						●	●			●	●					●				●			
PJT-24V40WBA□	●	●				●		●						●	●			●	●					●				●			
PJT-24V65WBA□	●	●	●			●		●						●	●			●	●					●				●			
PJT-24V100WBA□	●	●				●		●						●	●			●	●					●				●			
PJT-24V100WBB□	●	●				●		●						●	●			●	●					●				●			
PJT-27V150WBA□	●	●	●			●	●	●	●		●			●	●			●	●					●				●			
PJ-12V15W□NA	●	●				●		●						●	●			●	●					●				●			
PJ-12V30W□NA	●	●				●		●						●	●			●	●					●				●			
PJ-12V50W□NA	●	●				●		●						●	●			●	●					●				●			
PJ-12V100W□□A	●	●				●		●						●	●			●	●					●				●			
PJ-12V150W□□A	●	●				●		●						●	●			●	●					●				●			
PJ-24V30W□NA	●	●				●		●						●	●			●	●					●				●			
PJ-24V50W□NA	●	●				●		●						●	●			●	●					●				●			
PJ-24V100W□□A	●	●				●		●						●	●			●	●					●				●			
PJ-24V150W□□A	●	●				●		●						●	●			●	●					●				●			
PJ-5V15W□NA	●	●				●		●						●	●			●	●					●				●			
PJ-48V50W□NA	●	●				●		●						●	●			●	●					●				●			
PJB-24V100W□□A	●	●				●		●						●	●			●	●					●				●			
PJB-24V150WC□A	●	●				●		●						●	●			●	●					●				●			
PJB-24V150WL□A	●	●				●		●						●	●			●	●					●				●			
PJB-24V150WB□A	●	●				●		●						●	●			●	●					●				●			
PJB-24V150WG□A	○	○	○					○	○	○		○		○	○			○	○			○		○				○			
PJB-24V150WH□A	○	○	○					○	○	○		○		○	○			○	○			○		○				○			
PJB-24V150WJ□A	○	○	○					○	○	○		○		○	○			○	○			○		○				○			
PJB-24V240W□□A	●	●				●		●						●	●			●	●					●				●			
PJB-24V300W□□A	○	○	○					○	○		○		○	○	○			○	○			○		○				○			
PJH-24V300WBB□	●	●	●	●	●	●	●	●	●					●	●	△	●	●	●				●	●	●	●	●	●	●	●	
PJH-24V300WBC□	●	●	●	●	●	●	●	●	●					●	●	△	●	●	●				●	●	●	●	●	●	●	●	
PJH-36V300WBB□	●	●	●	●	●	●	●	●	●					●	●	△	●	●	●				●	●	●	●	●	●	●	●	
PJH-36V300WBC□	●	●	●	●	●	●	●	●	●					●	●	△	●	●	●				●	●	●	●	●	●	●	●	

Please visit www.DeltaPSU.com to check the certification status.

- Certified
- Pending

IEC/EN/UL 62368-1 implementation date is within December 2020.

STANDARDS & APPROVALS

| Industrial Power Supplies

	CE	CB Scheme to IEC 60950-1	CB Scheme to IEC 62368-1	CB Scheme to IEC 61347-1, IEC 61347-2-13	SIQ or TUV to EN 60950-1	SIQ or TUV to EN 62368-1	UL 60950-1	UL 62368-1	UL 508	UL 8750	CSA C22.2 No. 107.1-01	ATEX EN 60079-15	CSA C22.2 No. 213 and ANSI/ISA-12.12.09	BSMI	EAC (Eurasian Customs Union)	CCC (China)	KC (Korea)	RoHS Directive 2011/65/EU	RoHS Directive (EU) 2015/863 Compliant (EN 50581)	EN 61204-3	EN 61000-3-2 (PFC)	EN 61000-3-3 (Flicker)	EN 61000-6-1 (Immunity)	EN 61000-6-2 (Immunity)	EN 55014-2 (Immunity)	EN 55024 (Immunity)	EN 55011 Class B (Emissions)	EN 55032 Class A (Emissions)	EN 55032 Class B (Emissions)	EN 55014-1 (Emissions)	EN 61000-6-3 (Emissions)				
Open Frame Power Supply																																			
PJU-13V60W□A□	●	●	●		●	●	●	●								●		●	●		●	●				●									
PJU-13V60W□B□	●	●	●		●	●	●	●								●		●	●		●	●				●									
PJU-27V60W□A□	●	●	●		●	●	●	●								●		●	●		●	●				●									
PJU-27V60W□B□	●	●	●		●	●	●	●								●		●	●		●	●				●									
PJL-48V200WBAA	●	●	●	●	●	●	●	●		●								●	●		●	●				●									
PJL-48V400WBAA	●	●	●	●	●	●	●	●		●								●	●		●	●				●									
DIN Rail Modules																																			
DRR-20A	●	●	●		●	●	●	●	●			●	●		●			●	●				●	●			●								
DRR-20N	●	●	●		●	●	●	●	●						●			●	●				●	●			●								
DRR-40A	●	●	●		●	●	●	●	●			●	●		●			●	●				●	●			●								
DRR-40N	●	●	●		●	●	●	●	●						●			●	●				●	●			●								
DRB-24V020ABA	●	●	○		●	○	○	○			●	●	●		●			●	●		●	●				●									
DRB-24V020ABN	●	●	○		●	○	○	○	●		●	●	●		●			●	●		●	●				●									
DRB-24V040ABN	●	●	○		●	○	○	○	●		●	●	●		●			●	●		●	●				●									
DRU-24V40ABN	●	●	●		●	●	●	●	●		●	●	●		●			●	●		●	●				●									
DRU-24V10ACZ	●	●	○		●	○	○	○	●						●			●	●		●	●				●									
Adapter																																			
ADT-060A12AA	●	●	●		●	●	●	●						●		●	●	●	●				●	●			●								
ADT-060A12AB	●	●	●		●	●	●	●						●		●	●	●	●				●	●			●								
ADT-060A15AA	●	●	●		●	●	●	●						●		●	●	●	●				●	●			●								
ADT-060A15AB	●	●	●		●	●	●	●						●		●	●	●	●				●	●			●								
ADT-060A19AA	●	●	●		●	●	●	●						●		●	●	●	●				●	●			●								
ADT-060A19AB	●	●	●		●	●	●	●						●		●	●	●	●				●	●			●								
ADT-060A24AA	●	●	●		●	●	●	●						●		●	●	●	●				●	●			●								
ADT-060A24AB	●	●	●		●	●	●	●						●		●	●	●	●				●	●			●								

Please visit www.DeltaPSU.com to check the certification status.

● Certified
○ Pending
IEC/EN/UL 62368-1 implementation date is within December 2020.

Medical Power Supplies

	CE	CB Scheme to IEC 60950-1	CB Scheme to IEC 62368-1	CB Scheme to IEC 60601-1	SIQ or TUV to EN 60950-1	SIQ or TUV to EN 62368-1	TUV 60601-1	UL 60950-1	UL 62368-1	UL 60601-1	UL 508	CSA C22.2 No. 107.1-01	CSA C22.2 No. 60601-1	CSA C22.2 No. 213 and ANS/ISA-12.12.09	BSMI	EAC (Eurasian Customs Union)	CCC (China)	CQC (China)	KC (Korea)	RoHS Directive 2011/65/EU	RoHS Directive (EU) 2015/863 Compliant (EN 50581)	EN 61204-3	EN 61000-3-2 (PFC)	EN 61000-3-3 (Flicker)	EN 61000-6-1 (Immunity)	EN 61000-6-2 (Immunity)	EN 55024 (Immunity)	EN 55011 Class B (Emissions)	EN 55032 Class A (Emissions)	EN 55032 Class B (Emissions)		
Enclosed Power Supply																																
MDS-200ADB12	•	•		•	•		•	•		•							•			•	•								•		•	
MDS-250ADB12	•	•		•	•		•	•		•							•			•	•								•		•	
MDS-300ADB12	•	•		•	•		•	•		•							•			•	•								•		•	
MDS-400ADB12	•	•		•	•		•	•		•							•			•	•								•		•	
MDS-300ADB18	•	•		•	•		•	•		•							•			•	•								•		•	
MDS-200ADB24	•	•		•	•		•	•		•							•			•	•								•		•	
MDS-250ADB24	•	•		•	•		•	•		•							•			•	•								•		•	
MDS-300ADB24	•	•		•	•		•	•		•							•			•	•								•		•	
MDS-400ADB24	•	•		•	•		•	•		•							•			•	•								•		•	
MDS-300ADB48	•	•		•	•		•	•		•							•			•	•								•		•	
MEB-500A24F	•	•	•	•	•	•	•	•		•							•			•	•								•		•	
MEB-1K2A24T	•	•		•	•		•	•		•							•			•	•								•		•	
MEB-1K2A42T	•	•		•	•		•	•		•							•			•	•								•		•	
MEB-1K2A48T	•	•		•	•		•	•		•							•			•	•								•		•	
Open Frame Power Supply																																
MDS-040APS12 B	•	•		•			•	•		•							•			•	•								•		•	
MDS-065APS12 B	•	•		•			•	•		•								•			•	•							•		•	
MDS-100APS12 B	•	•		•			•	•		•								•			•	•							•		•	
MDS-100BPS12 B	•	•		•			•	•		•								•			•	•							•		•	
MDS-200APB12	•	•		•	•		•	•		•							•			•	•								•		•	
MDS-250APB12	•	•		•	•		•	•		•							•			•	•								•		•	
MDS-300APB12	•	•		•	•		•	•		•							•			•	•								•		•	
MDS-400APB12	•	•		•	•		•	•		•							•			•	•								•		•	
MDS-040APS15 B	•	•		•			•	•		•							•			•	•								•		•	
MDS-065APS15 B	•	•		•			•	•		•								•			•	•							•		•	
MDS-100APS15 B	•	•		•			•	•		•								•			•	•							•		•	
MDS-100BPS15 B	•	•		•			•	•		•								•			•	•							•		•	
MDS-040APS18 B	•	•		•			•	•		•								•			•	•							•		•	
MDS-065APS18 B	•	•		•			•	•		•								•			•	•							•		•	
MDS-100APS18 B	•	•		•			•	•		•								•			•	•							•		•	
MDS-100BPS18 B	•	•		•			•	•		•								•			•	•							•		•	
MDS-300APB18	•	•		•	•		•	•		•							•			•	•								•		•	
MDS-400AUS19 B	•	•		•			•	•		•								•			•	•							•		•	
MDS-400AUS24 B	•	•		•			•	•		•								•			•	•							•		•	
MDS-400AUS30 B	•	•	•	•			•	•		•								•			•	•							•		•	
MDS-040APS24 B	•	•		•			•	•		•								•			•	•							•		•	
MDS-065APS24 B	•	•		•			•	•		•								•			•	•							•		•	
MDS-100APS24 B	•	•		•			•	•		•								•			•	•							•		•	
MDS-100BPS24 B	•	•		•			•	•		•								•			•	•							•		•	
MDS-200APB24	•	•		•	•		•	•		•							•			•	•								•		•	
MDS-250APB24	•	•		•	•		•	•		•							•			•	•								•		•	
MDS-300APB24	•	•		•	•		•	•		•							•			•	•								•		•	
MDS-400APB24	•	•		•	•		•	•		•							•			•	•								•		•	
MDS-300APB48	•	•		•	•		•	•		•							•			•	•								•		•	
MDS-100AP401 B	•	•		•			•	•		•								•			•	•							•		•	
MEP-25A15J	•	•		•			•	•		•								•			•	•							•		•	
MEU-600C24T	•	•		•	•		•	•		•								•			•	•							•		•	
MEU-600C48T	•	•		•	•		•	•		•								•			•	•							•		•	

Please visit www.DeltaPSU.com to check the certification status.

• Certified
IEC/EN/UL 62368-1 implementation date is within December 2020.

STANDARDS & APPROVALS

| Medical Power Supplies

	CE	CB Scheme to IEC 60950-1	CB Scheme to IEC 62368-1	CB Scheme to IEC 60601-1	SIQ or TUV to EN 60950-1	SIQ or TUV to EN 62368-1	TUV 60601-1	UL 60950-1	UL 62368-1	UL 60601-1	UL 508	CSA C22.2 No. 107.1-01	CSA C22.2 No. 60601-1	CSA C22.2 No. 213 and ANSI/ISA-12.12.09	BSMI	EAC (Eurasian Customs Union)	CCC (China)	PSE (Japan)	RCM (Australia)	RoHS Directive 2011/65/EU	RoHS Directive (EU) 2015/863 Compliant (EN 50581)	EN 61204-3	EN 61000-3-2 (PFC)	EN 61000-3-3 (Flicker)	EN 61000-6-1 (Immunity)	EN 61000-6-2 (Immunity)	EN 55024 (Immunity)	EN 55011 Class B (Emissions)	EN 55032 Class A (Emissions)	EN 55032 Class B (Emissions)			
ATX Power Supply																																	
MDS-350AD701	•	•		•				•		•										•													
Configurable Power Supply																																	
MEG-1K2A4	•	•		•		•		•					•							•	•											•	
MEG-2K1A6	•	•	•	•				•	•				•							•	•											•	
Adapter																																	
MDS-005AAS05 A	•	•								•										•	•										•		•
MDS-005AAS05 B	•	•								•										•	•										•		•
MDS-005AAS05 C	•	•								•										•	•										•		•
MDS-030AAC05	•	•								•										•	•										•		•
MDS-005AAS06 A	•	•								•										•	•										•		•
MDS-005AAS06 B	•	•								•										•	•										•		•
MDS-005AAS06 C	•	•								•										•	•										•		•
MDS-030AAC07	•	•								•										•	•										•		•
MDS-030AAC12	•	•								•										•	•										•		•
MDS-060AAS12 B	•	•								•										•	•										•		•
MDS-060BAS12 A	•	•								•										•	•										•		•
MDS-080AAS12 A	•	•								•										•	•										•		•
MDS-150AAS12 B	•	•								•										•	•										•		•
MDS-030AAC15	•	•								•										•	•										•		•
MDS-060AAS15 B	•	•								•										•	•										•		•
MDS-090AAS15 B	•	•								•										•	•										•		•
MDS-060AAS19 B	•	•								•										•	•										•		•
MDS-060BAS19 A	•	•								•										•	•										•		•
MDS-090AAS19 B	•	•								•										•	•										•		•
MDS-150AAS19 B	•	•								•										•	•										•		•
MDS-150CAB19	•	•								•										•	•										•		•
MDS-030AAC24	•	•								•										•	•										•		•
MDS-060AAS24 B	•	•								•										•	•										•		•
MDS-060BAS24 A	•	•								•										•	•										•		•
MDS-090AAS24 B	•	•								•										•	•										•		•
MDS-090BAS24 A	•	•								•										•	•										•		•
MDS-150AAS24 B	•	•								•										•	•										•		•
MEA-065A12C	•	•	•	•			•			•										•	•										•		•
MEA-065A15C	•	•	•	•			•			•										•	•										•		•
MEA-065A19C	•	•	•	•			•			•										•	•										•		•
MEA-065A24C	•	•	•	•			•			•										•	•										•		•
MEA-250A24C	•	•		•						•										•	•										•		•

Please visit www.DeltaPSU.com to check the certification status.

• Certified
IEC/EN/UL 62368-1 implementation date is within December 2020.

| NOTES

A large empty rectangular box intended for taking notes.

| AUGMENTED REALITY (AR)

Our innovations in a new perspective.

Download **DeltaPSU AR** app to explore the products in 3D details.



4 easy steps

- 1 Download **DeltaPSU AR** app from the App Store or Google Play.



- 2 Open the app and select the "Scan AR" menu.
- 3 Scan product image with the  logo on the page to view the 3D product simulation.
- 4 Follow the instructions on the top right tab and users will be able to zoom in/out or rotate the product's 3D image for greater details.

*Software and Hardware Requirements
- iOS devices: Requires iOS 10.0 or above. Compatible with iPhone 5 or above; iPad 2 or above.
- Android devices: Requires Android 5.0 or above. Requires 1 GB RAM or above.

| MORE INFORMATION

For more information, find us at:



Facebook
www.facebook.com/DeltaPSU



LinkedIn
www.linkedin.com/company/deltapsu



Twitter
www.twitter.com/DeltaPSU



SlideShare
www.slideshare.com/DeltaPSU

Our responsive homepage adapts to desktop PC and mobile devices effortlessly.

Simply visit www.DeltaPSU.com for all your product needs.

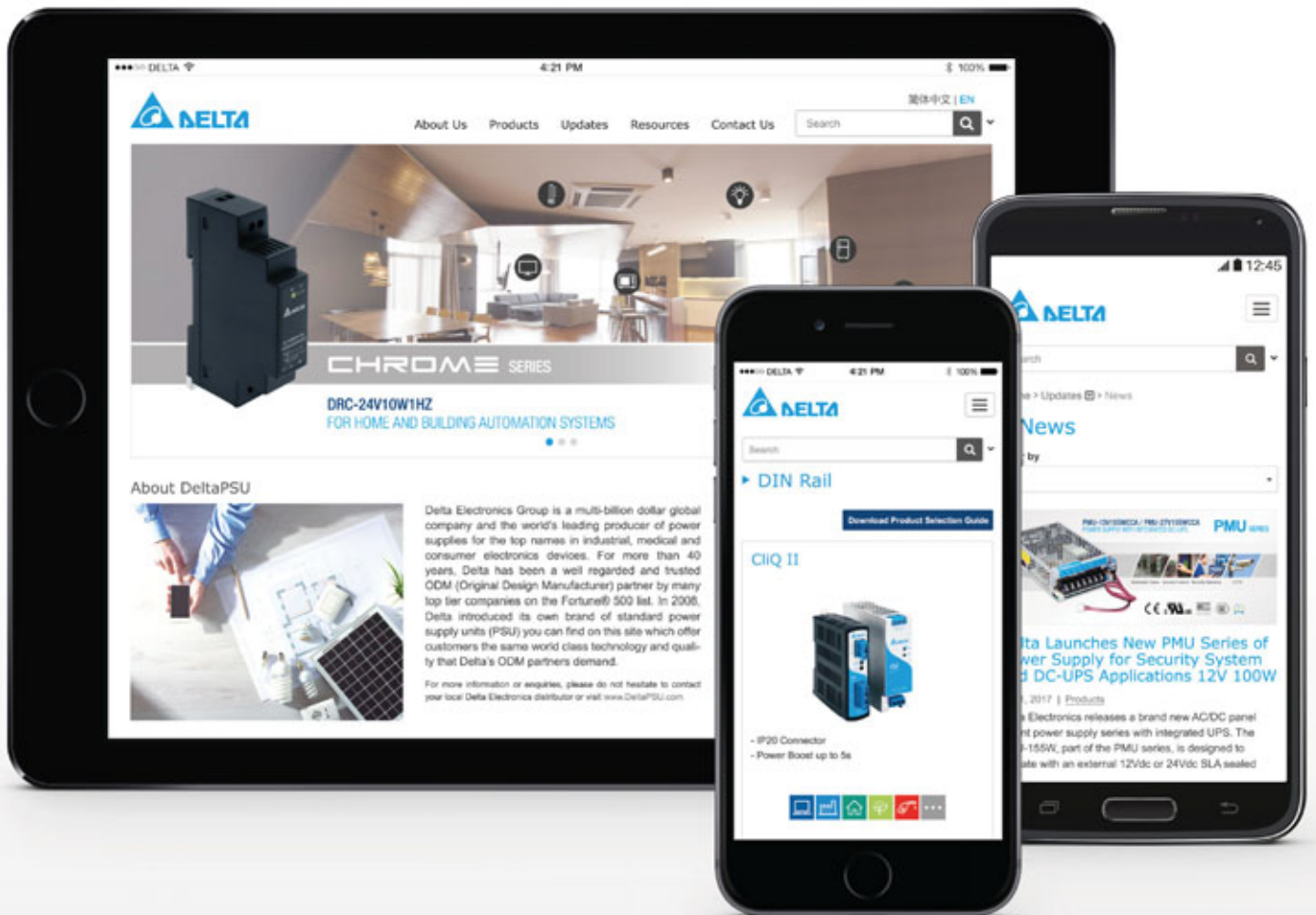

Subscribe to DeltaPSU newsletter and be the first to know the latest product news and industry knowledge.

| NOTES

Warranty

Delta warrants that the products (“Products”) sold in this catalog will be free of defects in material and workmanship within the warranty period. The warranty does not apply to Products which have been subjected to abuse, misuse, accident, neglect, unauthorized and/or improper installation, operation, use, maintenance, repair or alteration, or accident of unusual deterioration or degradation of the Products or parts thereof due to physical environment beyond the requirements of the Product specifications.

Attention

Delta provides all information in the catalog and datasheets on an “AS IS” basis and does not offer any kind of warranty through the information for using the product. In the event of any discrepancy between the information in the catalog and datasheets, the datasheets shall prevail (please refer to www.DeltaPSU.com for the latest datasheets information). Delta shall have no liability of indemnification for any claim or action arising from any error for the provided information in the catalog and datasheets. Customer shall take its responsibility for evaluation of using the product before placing an order with Delta.

Delta reserves the right to make changes to the information described in the catalog and datasheets without notice.

EMC Directives

At Delta, all of our products are designed to meet the highest quality standards. All national and international safety certifications including EMC directives are conducted by qualified and independent laboratories. For EMC directives’ compliance, the power supplies are tested to ensure compliance as a stand-alone product. Power supplies like the panel mount and open frame types are typically considered component power supply. Therefore, Delta cannot guarantee the system which is installed with Delta’s component power supply can meet the related EMC directives. Customers are advised to contact the system manufacturer for confirmation.

Availability

Products with “New” tab are slated for official release with immediate effect, while products with “Coming Soon” tab will be available within the next two months from this catalog’s publication month (refer to back cover page). Kindly contact your local Delta distributor for availability, ordering and delivery details. You may also get in touch with us via the Feedback Form on www.DeltaPSU.com/feedback.

GLOBAL OPERATION AND SERVICE



ASIA

Delta Electronics, Inc.

3 Tungyuan Road, Chungli Industrial Zone,
Taoyuan County 32063, Taiwan, R.O.C.

TEL: +886 3 452 6107
FAX: +886 3 434 3617

Delta Electronics (Shanghai) Co., Ltd. China Headquarters

No. 182 Minyu Road, Pudong,
Shanghai, P.R.C. 201209

TEL: +86 21 6872 3988
FAX: +86 21 6872 3996

Delta Electronics (Shanghai) Co., Ltd. Beijing Branch

No. 7 Building, 6th Courtyard, Beichen East Rd.,
Chaoyang Dist., Beijing, P.R.C. 100105

TEL: +86 10 8225 3225
FAX: +86 10 8225 1360

Delta Electronics (Thailand) PCL.

909 Soi 9, Moo 4, Bangpoo Industrial Estate
(E.P.Z.), Pattana 1 Rd., T. Phrakasa, A. Muang,
Samutprakarn 10280, Thailand

TEL: +66 2 709 2800
FAX: +66 2 709 2827

Delta Electronics India Pvt. Ltd.

Plot No. 43, Sector - 35, HSIIDC,
Gurgaon, Haryana 122001

TEL: +91 124 4874 900
+91 124 4169 040
FAX: +91 124 4874 945

Delta Electronics (Japan), Inc.

2-1-14 Minato-ku Shibadaimon,
Tokyo, 105-0012, Japan

TEL: +81 3 5733 1111
FAX: +81 3 5733 1211

Delta Electronics (Korea), Inc.

1504, Byucksan Digital Valley 6-Cha,
Gasan-dong, Geumcheon-gu, Seoul,
153-704, Korea

TEL: +82 2 515 5303
+82 2 515 5305
FAX: +82 2 515 5302

Delta Electronics (Australia) Pty Ltd

20-21, 45 Normanby Rd.
Nothing Hill, VIC 3168, Australia

TEL: +61 9543 3720
FAX: +61 9544 0606

Delta Energy Systems (Singapore) Pte Ltd

4 Kaki Bukit Avenue 1
#05-04, Singapore 417939

TEL: +65 6747 5155
FAX: +65 6744 9228

NORTH AMERICA

Delta Electronics (Americas) Ltd. North American Headquarters

46101 Fremont Blvd.
Fremont, CA 94538, U.S.A.

TEL: +1 510 668 5100
FAX: +1 510 668 0680

CENTRAL & SOUTH AMERICA

Delta Electronics International Mexico S.A. de C.V.

Centrum Park, Av. Gustavo Baz Prada 309
Edificio E Planta Baja, Col. La Loma, C.P.
54030 Tlalnepantla, Estado de México

TEL: +52 55 3603 9200

Delta Greentech (Brasil) S.A.

Rua Itapeva, 26 - 3º, andar - Bela Vista
01332-000 - São Paulo - SP - Brasil

TEL: +55 11 3568 3850
FAX: +55 11 3568 3865

EUROPE

Delta Electronics (Netherlands) B.V. EMEA Headquarters

Zandsteen 15
2132 MZ Hoofddorp, The Netherlands

TEL: +31 20 800 3900
FAX: +31 20 800 3999

De Witbogt 20, 5652 AG Eindhoven,
The Netherlands

TEL: +31 40 800 3800
FAX: +31 40 800 3898

www.DeltaPSU.com | info@deltapsu.com

October 2019 - All information and specifications are subjected to change without prior notice.